

See discussions, stats, and author profiles for this publication at: <https://www.researchgate.net/publication/28138864>

Systematic relationships of some species of the genus *Androcymbium* Willd. (Colchicaceae) in western South Africa

Article · January 2003

Source: OAI

CITATIONS

6

READS

104

4 authors, including:



Joan Pedrola-Monfort
University of Valencia

41 PUBLICATIONS 510 CITATIONS

[SEE PROFILE](#)



Juli Caujapé-Castells
Cabildo de Gran Canaria

123 PUBLICATIONS 1,967 CITATIONS

[SEE PROFILE](#)



Josep María Montserrat Martí
Spanish National Research Council

62 PUBLICATIONS 461 CITATIONS

[SEE PROFILE](#)

Some of the authors of this publication are also working on these related projects:



Congress FloraMac 2018 (Funchal, Madeira Island, Portugal) [View project](#)



DNA barcoding for plant-pathogens diagnostic and monitoring. Forest diseases and turbo-taxonomy in Tympanidaceae as a case of study [View project](#)

SYSTEMATIC RELATIONSHIPS OF SOME SPECIES OF THE GENUS *ANDROCYMBIUM* WILLD. (COLCHICACEAE) IN WESTERN SOUTH AFRICA

J. PEDROLA-MONFORT¹, N. MEMBRIVES¹, J. M. MONTSERRAT² AND J. CAUJAPÉ-CASTELLS³

¹ Estació Internacional de Biologia Mediterrània - Jardí Botànic Marimurtra. Passeig Karl Faust, 10. 17300 - Blanes. Girona. Apdo. Correos 112. Spain. (jpedrola@grn.es; nuriamem@jazzfree.com)

² Institut Botànic de Barcelona-CSIC. Avda. Muntanyans s/n, Montjuïc. Barcelona. Spain. (jmmontserrat@ibb.csic.es).

³ Jardín Botánico Canario «Viera y Clavijo». Apdo. 14 de Tarifa Alta. 35017 Las Palmas de Gran Canaria. Spain. (julicaujape@grancanaria.com)

Palabras clave: *Androcymbium*, Colchicaceae, similaridad, filogenia, taxonomía, África.

Key words: *Androcymbium*, Colchicaceae, similarity, phylogeny, taxonomy, Africa.

SUMMARY

Recent morphological and allozymic studies are discussed in five taxa of genus *Androcymbium* from the western region of the Cape province (South Africa) in the context of the systematic implications of phylogenetic analysis based on cpDNA and morphologic data. Based on this synthesis, we modify the taxonomic category of *A. latifolium*, that is included as a subspecies of *A. burchellii*. These five taxa (*A. burchellii* subsp. *burchellii*, *A. burchellii* subsp. *pulchrum*, *A. eghimocymbion*, *A. huntleyi* and *A. walteri*) are described and illustrated.

RESUMEN

Recientes estudios de similaridad aloenzimática y filogenia (en base a caracteres morfología y RFLPs del cpDNA) permiten la discusión de sus implicaciones sistemáticas en cinco especies del género *Androcymbium*. Con los datos obtenidos reestructuramos la categoría taxonómica de la especie *A. latifolium* incluyéndola como subespecie de *A. burchellii*. Estos cinco táxones (*A. burchellii* subsp. *burchellii*, *A. burchellii* subsp. *pulchrum*, *A. eghimocymbion*, *A. huntleyi* y *A. walteri*) son descritos e ilustrados.

INTRODUCTION

Androcymbium Willd. (Colchicaceae) consists of about 50 species (ARNOLD & WET, 1993; MÜLLER-DOBLIES & MÜLLER-DOBLIES, 1998; PEDROLA-MONFORT *et al.* 1999a, 1999b) with a disjunct distribution in Africa (Figure 1). Most of them (about 40) occur in the western region of South Africa, only seven in eastern South Africa and six in North Africa (four in the Mediterranean basin and two in the Canary Islands). WILLDENOW (1808) segregated the species of genus *Melanthium* L. with tepals differentiated in lamina and claw and grouped them into the genus *Androcymbium*.

Species of genus *Androcymbium* are herbaceous plants with a tunicated corm, that show cataphylls of papery texture at senescence. Leaves dispose alternately, distically, tristically or spirally in the stem. The bracts are usually shorter and wider than leaves and differ from these in texture and color. As a rule, the third leaf shows an intermediate morphology. The flowers have six tepals differentiated into lamina and claw, each with a stamen inserted at the base of the tepal's lamina. The nectaries are situated at the base of the filament. Some species show the nectary in the dorsal side of the filament (opposite the lamina), while others show a cylindrical nectary around the filament. The ovary is tricarpeal and trilocular, and the fruit is a capsule, either indehiscent or dehiscent with a septicide aperture, coriaceous or papery in texture. Most of species show idioblasts in the leaves, tepals and capsules that are easily identified by densely distributed red spots.

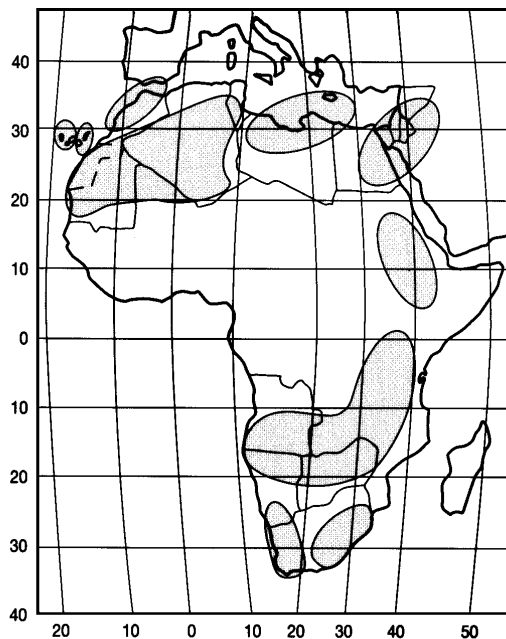

Figure 1.- Geographic distribution of the genus *Androcymbium*.

During the past ten years, detailed morphological and allozymic studies in 61 populations that represent 24 species of *Androcymbium* have been carried out by our group (PEDROLA-MONFORT & CAUJAPÉ-CASTELLS 1994, 1995, 1996, 1998; MEMBRIVES, 2000) using a collection of more than 4000 individuals from northern and southern Africa maintained in culture in the greenhouses of the “Estació Internacional de Biologia Mediterrània-Jardí Botànic Marimurtra”. Recently, our group has produced works on the phylogeny based on morphological (MEMBRIVES, 2000) and cpDNA RFLPs data (CAUJAPÉ-CASTELLS *et al.*, 1999b), and dispersal dynamics of the genus (CAUJAPÉ-CASTELLS & PEDROLA-MONFORT, 1997; CAUJAPÉ-CASTELLS *et al.*, 1999a). This diverse information spectrum regarding similarity and phylogenetic relatedness in the genus allowed us to establish complete comparisons at the population and species levels. In this study, we will consider five taxa (*A. burchellii* Baker subsp. *burchellii*, *A. burchellii* Baker subsp. *pulchrum* Pedrola, Membrives, J. M. Monts. & Caujapé, *A. eghimocymbion* U. Müll.-Doblies & D. Müll.-Doblies, *A. huntleyi* Pedrola, Membrives, J. M. Monts. & Caujapé, and *A. walteri* Pedrola, Membrives & J. M. Monts.) which are paradigmatic examples of systematic agreements and discrepancies among the available datasets. Given the generalized lack of information for the species of the genus, we include the description and illustrations of the five species analysed.

MATERIAL AND METHODS

Morphological characterizations of the material included in this survey are based on both cultured and herbarium specimens (see Appendix). Morphological and allozymic similarity data are from MEMBRIVES (2000). The morphological similarity tree was built from 56 characters (both biometric and qualitative) applying the taxonomic distance option in NTSYS-pc (ROHLF, 1992). The allozymic similarity tree was generated from NEI's (1978) genetic distance based on frequency data of 16 loci in BIOSYS-1 version 1.7 (SWOFFORD & SELANDER, 1981). The morphological phylogeny (MEMBRIVES, 2000) was constructed based on 44 morphological and reproductive traits using the option mult*1000 in NONA 2.0 (GOLOBOFF, 1993). One of the 27 most parsimonious trees was used as a phylogenetic hypothesis of interspecies relationships. The cpDNA RFLP phylogeny (CAUJAPÉ-CASTELLS *et al.*, 1999b), was obtained by random addition sequence (100 replicates) and the TBR algorithm within the option branch swapping in PAUP* versión 4d64 (D. SWOFFORD, with permission) with MULPARS and ACCTRAN character optimization.

RESULTS AND DISCUSSION

1. **The previously known species *Androcymbium burchellii* Baker and *A. latifolium* Schinz: a new proposal to include *A. latifolium* as a subspecies of *A. burchellii* (Figures 2-5)**

Androcymbium burchellii is morphologically very similar to *A. latifolium* Schinz.

Both of them have ovate, thick leaves with scarce short multi-cellular hairs along the edge, tepal's claw more than twice the length of the lamina, anthers noticeably exerted and the filament thickened at the base (Figs. 3-5). Reproduction system is preferentially self-incompatible and the nectar gives off a strong disagreeable smell. According to the information available they have different chromosome number: $2n=22$ in *A. burchellii* and population CA of *A. latifolium* (from Calvinia), and $2n=20$ in population NI of *A. latifolium* (from Nieuwoudtville) (Montserrat *et al.*, in prep.). Most of the floral characters studied do not differ substantially between them (Table 1). Nevertheless, a remarkable difference is the purple abaxial face of the leaves and the white bracts with a green reticulation in *A. burchellii*, whereas *A. latifolium* shows a green abaxial face and purple bracts. Floral biometric measurements are superior in population NI of *A. latifolium* those in population CA of *A. latifolium* or in *A. burchellii*. Accordingly, the morphological similarity tree (Fig. 2A) separates both populations of *A. latifolium* (NI) and joins *A. latifolium* (CA) to *A. burchellii*. In contrast, both populations of *A. latifolium* appear in the same cluster in the allozyme tree (Fig 2B). Genetic identity between *A. burchellii* and *A. latifolium* (CA) is 0.894, and that between *A. burchellii* and *A. latifolium* (NI) is 0.898 (MEMBRIVES, 2000). These values are similar to the genetic identities between subspecies or between conspecific populations (CRAWFORD, 1990). These pieces of evidences and the considerable morphological similarity between them do not support the separation of these. The morphological (MEMBRIVES, 2000) and cpDNA RFLP (CAUJAPÉ-CASTELLS *et al.*, 1999b) hypotheses of phylogenetic relationships coincide in grouping these two taxa in the same clade (Fig. 2C,D).

Recent crossability experiments realized between *A. burchellii* and *A. latifolium* produced a small percentage of viable seeds (MEMBRIVES *et al.*, in prep.) which indicate a substantial degree of reproductive isolation between both taxa. In addition, their geographic distribution is well delimited. *Androcymbium burchellii* occurs in the Great Karoo around Sutherland, from top of Botterklof Pass in the west to the Nuweveldberge in the east and Bloutouring near Montagu in the south. *Androcymbium latifolium* is distributed in the Great Karoo NW of the *A. burchellii* area, from Nieuwoudtville to Sutherland (in MÜLLER-DOBLIES & MÜLLER-DOBLIES, 1998). Therefore, is no evidence of sympatric overlapping between both taxa. Thus, following STUESSY (1990) we consider it justified to propose their separation into two subspecies of *A. burchellii* using the priority criterion: *A. burchellii* subsp. *burchellii* and *A. burchellii* subsp. *pulchrum*.

Species	n	LL	LF	AA*	LE*
<i>A. burchellii</i>	22	6.37±0.94	10.19±1.25	2.71±0.25	14.69±1.70
<i>A. latifolium</i>	29	6.16±1.46	10.73±2.95	2.99±0.71	16.10±2.72

Table 1.- Mean and standard deviation for the most important characters in the differentiation of *A. burchellii* and *A. latifolium*. n: number of individuals studied. LL: tepal's lamina length, LF: filament length, AA: anther width, and LE: style length. The characters were measured in mm. Asterisks after variable codes signal significant differences between the two species at the 0.05 level.

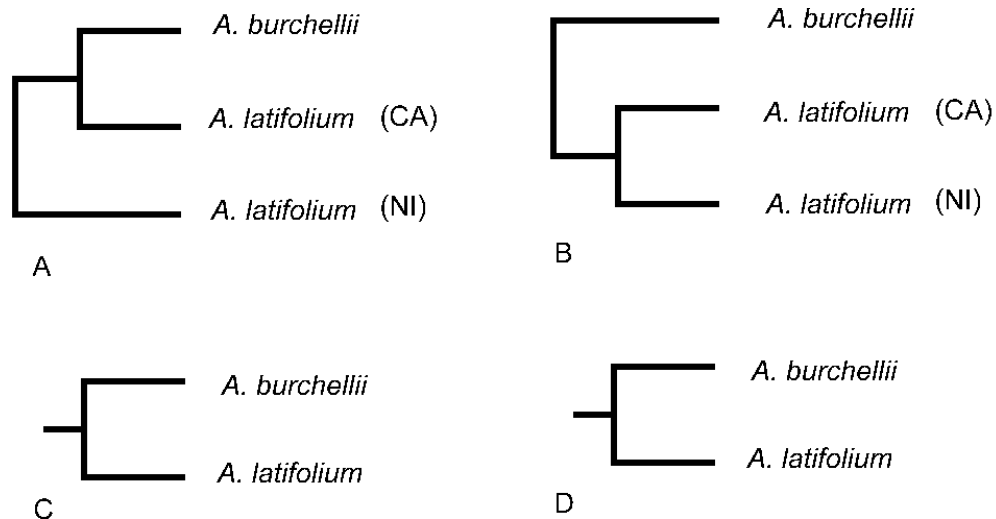

Figure 2.- Similarity relationships between *A. burchellii* and *A. latifolium* in terms of (A) morphological and (B) allozymic data and phylogenetic relationships according to (C) morphological and (D) cpDNA RFLPs. CA: Calvinia, NI: Nieuwoudtville.

Keys of determination for the subspecies of *A. burchellii*:

- Leaves green at the adaxial face and purple at the abaxial face, margin with a purple line in the outer part. Bracts white with green longitudinal and transversal nerviations forming a reticulate pattern***A. burchellii* subsp. *burchellii***
- Leaves green at both faces, margin without a purple line. Bracts reddish.
.....***A. burchellii* subsp. *pulchrum***

Androcymbium burchellii* Baker subsp. *burchellii

Typus: *A. burchellii* Baker in *J. Bot.* 12 (1874) 246. Herbarium Burchell 1401 ex Baker.

Corm ovoid, (9)14(20) mm in diameter, with a narrow basal crest; tunics brown-reddish, dark, coriaceous and smooth. Cataphyll white and striped purple, up to 5 mm, papery in texture at senescence. Leaves distichous, ovate-lanceolate, fleshy, (125)159(210) x (16)23(37) mm, amplexicaule, green at the adaxial face and purple at the abaxial face, apex acute; margin with a white wing with multi-cellular short hairs (formed by 4-6 cells), more frequently near the apex, and a purple line in the outer part due to the abundancy of idioblasts. Bracts different in shape and texture to leaves, white with green longitudinal and transversal nerviations forming

a reticulate pattern, margin without indument. The first bract orbicular, (30)39(60) x (30)43(52) mm, apex rounded; the others bracts ovate-lanceolate, (40)49(60) x (15)18(25) mm, apex acute. Flowers sessile, 1-6 per corm, pestilent scented; perianth 15-28 mm; tepal's lamina deltoideous, recurved, apex acute, (4.7)6.4(9) x (5.3)6.6(8.5) mm, green, with semi-transparent auricles few developed; claw (10.5) 13.6 (18) mm long, white striped purple. Stamens noticeably exserted; filaments cylindrical, (8)10.2(13) mm long, purple; anthers lanceolate, (5.7)6.7(8) x (2.2)2.7(3.2) mm, purple; nectary cylindrical, purple, 4 times wider than the filament. Ovary subglobose, (6)7.4(10) mm long; style (11)14.7(18) mm long; stigma papillose, punctiform, purple. Capsule globose, dehiscent, (13)15(18) x (13)15.5(17) mm. Seeds globose, (1.8)2(2.6) mm in diameter, testa dark brown and rough, without a developed raphe. Abundant idioblasts present on leaves, tepals and capsule. Pollen diaphragm with microrreticulate surface sculpturing, 11.2x19.8x12.6 μm . Species preferently self-incompatible. Low levels of vegetative reproduction in cultivation. $2n=22$.

Flowering in August-September (December-January in J.B. Marimurtra).

Distribution: Great Karoo around Sutherland, from top of Botterkloof Pass in the west to the Nuweveldberge in the east and Bloutouring near Montagu in the south.

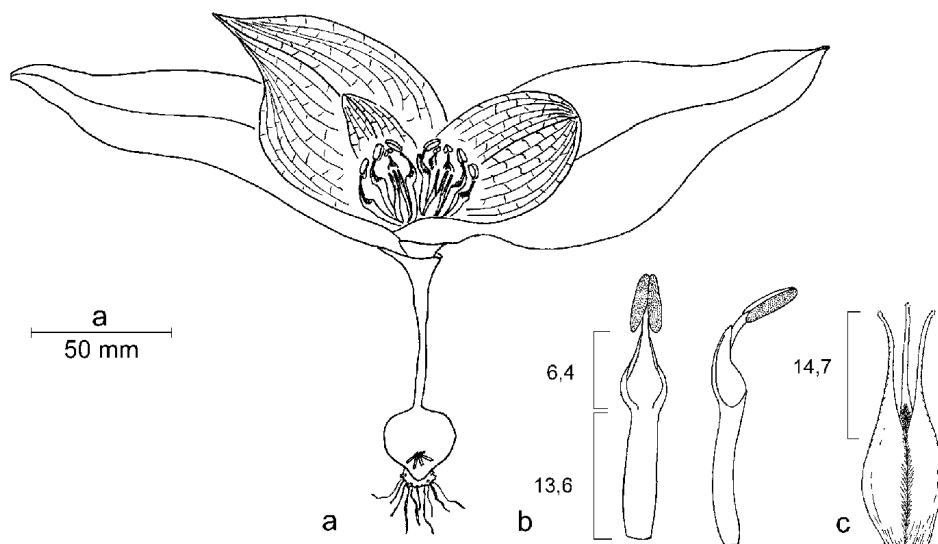

Figure 3.- *Androcymbium burchellii* Baker subsp. *burchellii* a: plant general view. b: tepal. c: capsule immature. (Measures of b-c are expressed in mm).

Androcymbium burchellii Baker subsp. ***pulchrum*** (Baker) Pedrola, Membrives, J.M.Monts. & Caujapé *comb. et stat. nov.*

=*A. latifolium* Schinz. In *Bull. Herb. Boissier* IV (1894): 415. *Typus*: Süd-Africa, Hamtam-Geb. 1869, Dr. Meyer (*comm.* Purcell) Herbarium de Zürich (Z) holo!

=*A. pulchrum* Schltr. & K. Krause. In *Notizbl. Bot. Gart. Berlin-Dahlem* 7: 522 (1920). *Typus*: Northern Cape.- (Calvinia): Onder-Bokkeveld, Oorgskloof, 21-08-1897. Schlechter 10953. Herbarium Berlin (B) holo!

Corm ovoid (10.7)12.8(16) mm in diameter, with a narrow basal crest; tunics brown-reddish, dark, coriaceous and smooth. Cataphyll white and striped purple, up to 5 mm, papery in texture at senescence. Leaves distichous, ovate-lanceolate, fleshy, (70)130(230) x (14)29(56) mm, amplexicaule, green, apex acute; margin with a white wing with multi-cellular short hairs (formed by 4-6 cells), more frequently near the apex. Bracts different in shape and texture to leaves, red, margin without indument. The first bract ovate-orbicular, apex rounded; the others bracts ovate-lanceolate, (40)74(125) x (45)63(90) mm, apex acute. Flowers sessile, 1-5 per corm, pestilent scented; perianth 17-28 mm; tepal's lamina deltoideous, recurved, apex acute, (7)8(9) x (3)4.2(5) mm, green, with semi-transparent auricles few developed; claw (10)14.1(18.5) mm, white striped purple. Stamens noticeably exerted; filaments cylindrical, (13)14.6(16) mm, green or purple; anthers lanceolate, (5.7) 6.8 (7.5) x (2.7) 3 (3.4) mm, pink-purplish; nectary cylindrical, purple, 4 times wider than the filament. Ovary subglobose; style (17)19.3(21) mm; stigma papillose, punctiform, purple. Capsule globose, dehiscent (13)15(18) x (14)15.5 (17) mm. Seeds globose, (1.9) 2.6 (3.5) mm in diameter, testa dark brown and rough, without a developed raphe. Abundant idioblasts present on leaves, tepals and capsule. Pollen diaphragm with microrreticulate surface sculpturing, 12.1x22.5x13.3 μm . Species preferently self-incompatible. Low levels of vegetative reproduction in cultivation. $2n=20, 22$.

Flowering in August-September (December-January in J.B. Marimurtra).

Distribution: Great Karoo NW of the *A. burchellii* area, from Nieuwoudtville to Sutherland.



Figures 4-5. - *Androcymbium burchellii* subsp. *burchellii*, from cultivation (4). *Androcymbium burchellii* subsp. *pulchrum*, from cultivation (5).

2. *Androcymbium eghimocymbion* U.Müll.-Doblies & D.Müll.-Doblies (Figures 6-9).

Corm globose (4.1)6.2(10.5) mm in diameter, the basal crest as wide as the corm; tunics brown, coriaceous and smooth. Cataphyll membranous and white, papery in texture at senescence. Leaves distichous, linear-lanceolate, 75-120 (270 mm in cultivation) x (5)10(16) mm, amplexicaule, green, apex acute, margin densely toothed. Bracts deltoideous, similar in texture to leaves, (25)41(80) x (17)28(40) mm, green, apex rounded, margin densely toothed. Flowers subsessile (10 mm long), 1-5 per corm, odourless; perianth 7-13 mm; tepal's lamina deltoid, conspicuously concave, recurved, apex mucronate, (3.2)4.7(6) x (5)6.9(9.8) mm, green, with transparent auricles; claw (3.5)4.9(6.8) mm long, white and purple striped. Stamens exerted; filament (3.5)5.7(7.2) mm long, green; anthers oval, (2.6)3.5(4.2) x (1.2)1.7(2) mm, red; nectary cylindrical, purple, slightly wider than the filament. Ovary subglobose; style (2.5)3.2(4) mm long; stigma papillose, capitate, purple. Capsule oblong, dehiscent, (9)12.6(17) x (6)8.4(11) mm. Seeds globose, (1.2)1.5(1.7) mm in diameter, testa dark brown, rough and without developed raphe. Abundant idioblasts present on leaves, tepals and capsule. Pollen triaperturate with perforate surface sculpturing, de 16.2x27.2x17.2 μ m. Species self-compatible, sometimes cleistogamous. Vegetative reproduction absent in cultivation.

Flowering in August (January in J.B. Marimurtra).

Distribution: Cape Province, in the mountain regions of the Karoo, between Wuppertal and Cape Town.

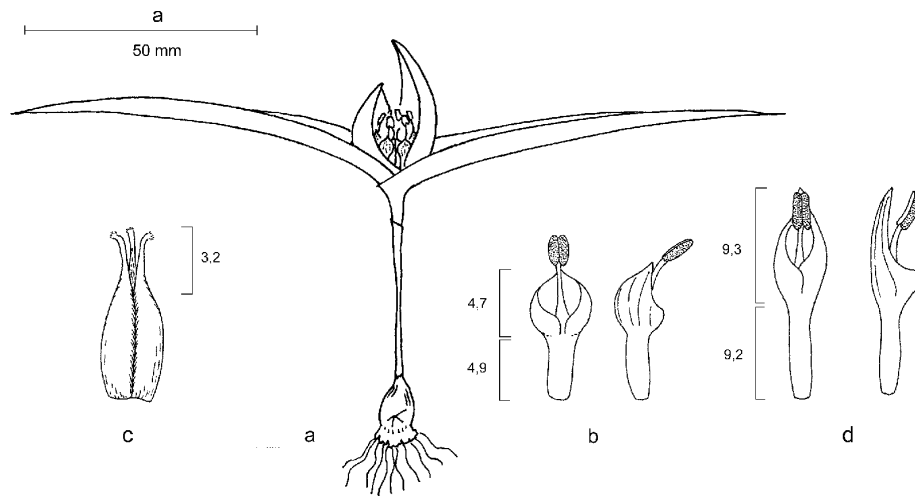

Figure 6. - *Androcymbium eghimocymbion* U.Müll.-Doblies & D.Müll.-Doblies. a: plant general view. b: tepal. c: immature capsule. d: tepal from *A. austrocapense*. (Measures of b-d are expressed in mm).

Androcymbium eghimocymbion differs morphologically from *A. austrocapense* U.Müll.-Doblies & D.Müll.-Doblies in showing a shorter tepal, a lamina more concave and exerted anthers (Figs. 6-9, table 2). Furthermore, the seed testa in *A. austrocapense* is fleshy, which is a unique feature among the species of *Androcymbium* studied. Both species are self-compatible and have odourless nectar. Both species have three pore apertures. They occur in the vegetation type known as Fynbos: *A. austrocapense* is found in litoral dunes whereas *A. eghimocymbion* prefers mountainous areas. The studied populations in each species appear consistently grouped in the morphological and allozymic similarity trees, but the genetic identity between them is very low (0.356 in MEMBRIVES, 2000), corresponding to values reported for species belonging to different genera (GOTTLIEB, 1981). The morphological phylogenetic hypothesis places *A. eghimocymbion* at the base of a clade (MEMBRIVES, 2000), with *A. austrocapense* and *A. eucomoides* as the closer derived species. In contrast, the cpDNA RFLP phylogenetic hypothesis separates these species into two clades. On the one hand, *A. austrocapense* is basal in the clade containing the North African species. On the other hand, *A. eghimocymbion* is basal in the clade with the South African species (Fig. 7). This example illustrates a discrepancy between different sources of data. At the morphological level, both similarity and phylogeny group *A. eghimocymbion* and *A. austrocapense*. Instead, allozymes reveal a very low identity between them, and cpDNA RFLPs separate them in two different, well-supported clades. This contrasting topological positioning of the two species under morphological or molecular data seems supportive of a fast evolution of molecular traits respect to morphological features in these two species.

Species	n	LL*	LU*	LA*	LE*
<i>A. eghimocymbion</i>	25	4.73±0.7	4.87±0.7	3.51±0.4	3.22±0.3
<i>A. austrocapense</i>	63	9.26±1.4	9.24±1.0	3.92±0.6	6.78±0.9

Table 2. - Mean and standard deviation for the most important characters in the differentiation of *A. eghimocymbion* and *A. austrocapense*. n: number of individuals studied. LL: tepal's lamina length, LU: tepal's claw length, LA: anther length, and LE: style length. The characters were measured in mm. Asterisks after variable codes signal significant differences between the two species at the 0.05 level.

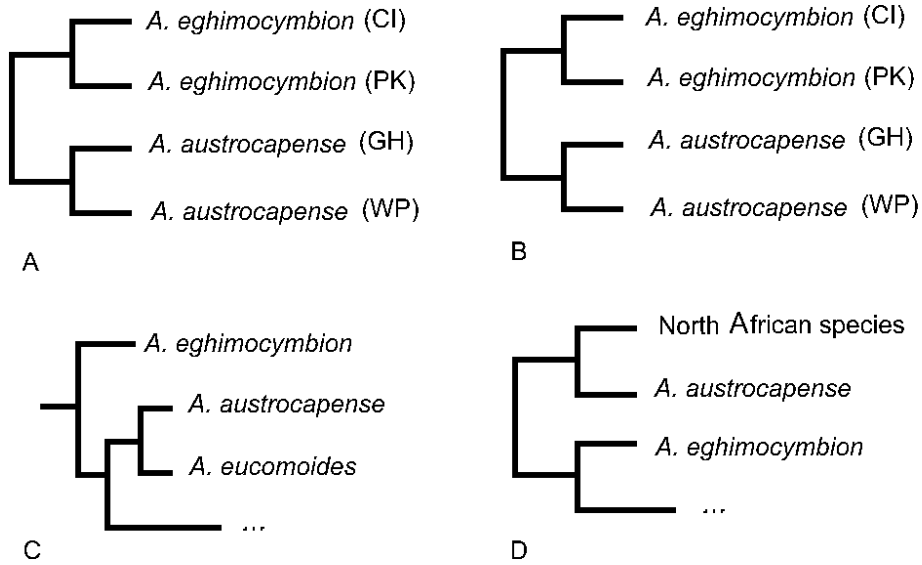
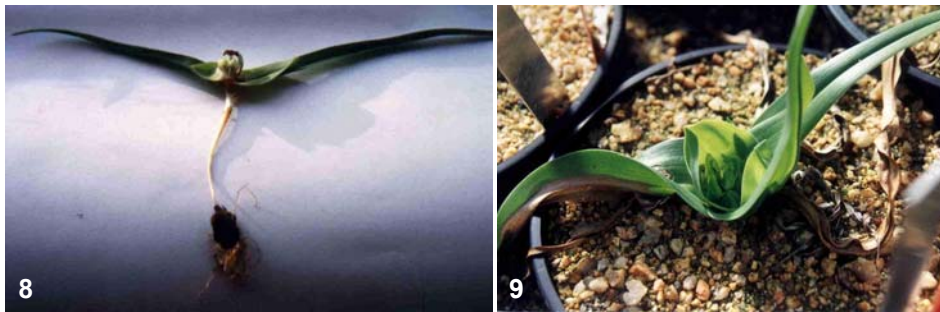

Figure 7.- Similarity relationships between *A. eghimocymbion* and *A. austrocapense* in terms of (A) morphological and (B) allozymatic data and phylogenetic relationships according to (C) morphological data and (D) cpDNA RFLPs. CI: Citrusdal, PK: Pakhuispas, GH: Good Hope, WP: Whale's Point.



Figures 8-9.- *Androcymbium eghimocymbion*, from the field (8). *Androcymbium austrocapense*, from cultivation (9).

3. *Androcymbium huntleyi* Pedrola, Membrives, J.M.Monts. & Caujapé. *In Fontqueria* (1999) 53: 1 (BC 834977; NBG) (Figures 10-13)

Corm globose (7.6)10.2(13) mm wide, the basal crest as wide as the corm; tunics brown, coriaceous and smooth. Cataphyll membranous and white, papery in texture at senescence. Leaves distichous, lanceolate (55)81(92) x (8)12(18) mm, amplexicaule, glaucous, apex apiculate, margin without indument. Bracts elliptic-delloideous with similar texture to the leaves, (15)17(20) (40 mm in cultivation) x (16)18(21) mm, glaucous, margin winged with a very few papilles. Flowers sessile,

1-2 per corm; perianth 7-10 mm long; tepal's lamina deltoideous, recurved, apex acute, (2.5)3.4(4.7) x (2)2.8(4.5) mm, white, semi-transparent, auricles scarcely developed; claw (2.5)3.5(4.2) mm long, white-greenish. Stamens exerted; filaments cylindrical (3)4.5(5.5) mm long, light green; anthers oval (1.2)1.6(2) x (0.8)1.2(1.5) mm, yellow; nectary cylindrical, yellow and orange in its maturity, 3-4 times wider than the filament. Ovary subglobose; style (2.5)2.8(3) mm long; stigma papillose, subpunctiform, green. Capsule globose, dehiscent, (12)13(15) x (9)10.2(13.5) mm. Seeds globose, (1.3)1.4(1.6) mm in diameter; testa dark brown, rough and without developed raphe. Abundant idioblasts present on leaves, tepals and capsule. Pollen diaphragm with microrugulate-perforate-reticulate surface sculpturing, 19.3x26.4x19.6 μm . Species self-compatible. Vegetative reproduction observed in cultivation. $2n=18$.

Flowering in August (November-December in J.B. Marimurtra).

Distribution: Cape Province. Namaqualand, near Eksteenfontein.

Androcymbium huntleyi is similar to *A. henssenianum* U.Müll.-Doblies & D.Müll.-Doblies (Figs. 12-13) in the yellow colour of the anthers and the linear or subpunctiform stigma, never punctiform. However, *A. huntleyi* presents an exerted stamen, a short style and leaves and bracts morphologically differentiated, whereas *A. henssenianum* features semi-exserted stamen, a style twice as long as the style of *A. huntleyi* and leaves and bracts that differentiate gradually (Fig. 10, Table 3). Morphological similarity data group the populations of both species, thereby indicating that they are very closely related under phenetic tenets (Fig. 11A). Both of them appear in the same clade at the morphological phylogeny and therefore they share a recent common ancestor (Fig. 11C). However, these species are considerably distant in the UPGMA tree with allozymic data (Fig. 11B) and show a genetic identity of 0.203 (MEMBRIVES, 2000), which is a very low value that corresponds to species belonging to different genera according

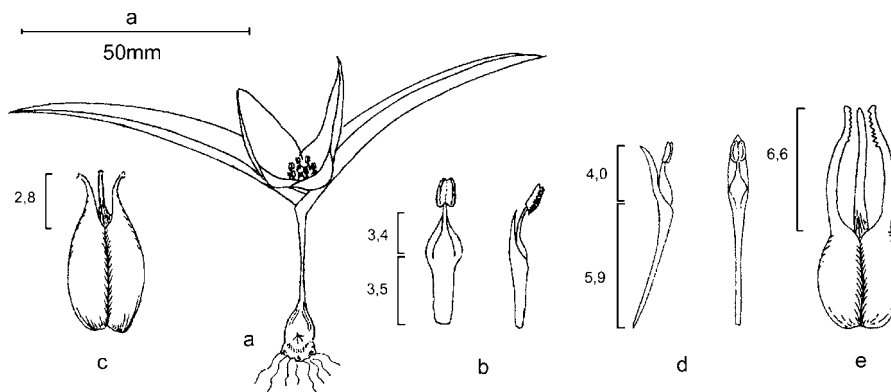

Figure 10. - *Androcymbium huntleyi* Pedrola, Membrives, J.M.Monts. & Caujapé. a: plant general view. b: tepal. c: capsule immature. d: tepal of *A. henssenianum*. e: capsule immature of *A. henssenianum* (Measures of b-e are expressed in mm).

to GOTTLIEB (1981). In the allozyme tree, *A. henssenianum* groups with *A. burchellii* and *A. latifolium*, whereas *A. huntleyi* is close to *A. dregei*. Data bearing on cpDNA RFLPs are not available for these two species. This example illustrates a coincidence between morphological similarity and phylogeny (that implies a close relationship between these species) which is not supported at the level of allozymic similarity. This result also suggests a faster evolution of allozymic traits than of morphological features.

Species	n	LU*	LA*	LE*	LC*
<i>A. henssenianum</i>	33	5.87±1.7	1.21±0.2	6.64±0.7	6.72±1.0
<i>A. huntleyi</i>	6	3.55±0.6	1.64±0.3	2.76±0.2	13.00±1.1

Table 3.- Mean and standard deviation for the most important characters in the differentiation of *A. huntleyi* and *A. henssenianum*. n: number of individuals studied. LU: tepal's claw length, LA: anther length, LE: style length, and LC: Capsule length. The characters were measured in mm. Asterisks after variable codes signal significant differences between the two species at the 0.05 level.

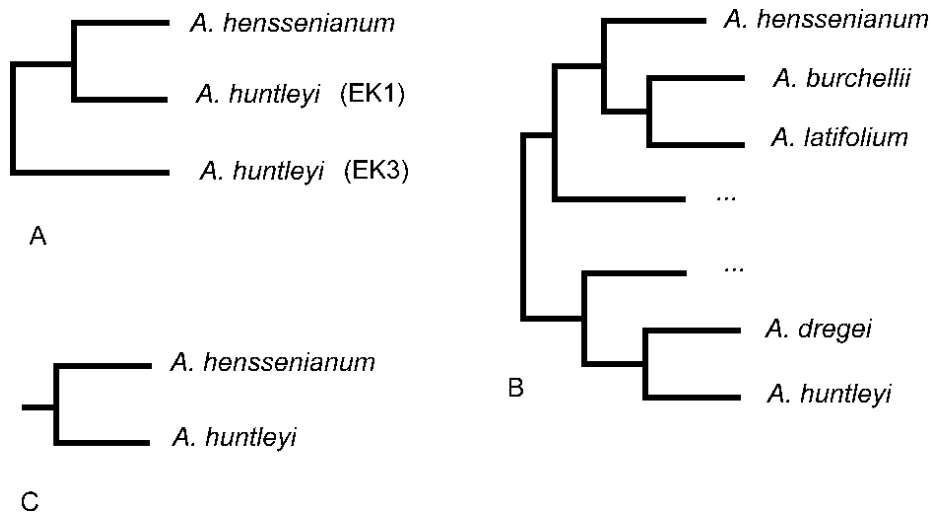
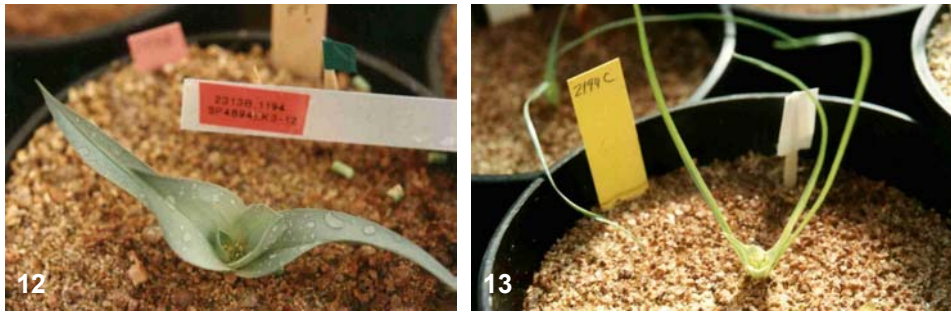

Figure 11.- Similarity relationship between *A. burchellii* and *A. latifolium* in terms of (A) morphological and (B) allozymic data. C: phylogenetic relationships according to morphological data. EK1: 14 km to Eksteenfontein, EK3: 20 km to Eksteenfontein.



Figures 12-13.- *Androcymbium huntleyi*, from cultivation (12). *Androcymbium henssenianum*, from cultivation (13).

4. *Androcymbium walteri* Pedrola, Membrives & J.M.Monts. In *Fontqueria* (1999) 54(2): 7-9 (BC 834975; Herb. Jardí Botànic Marimurtra; MA; NBG) (Figures 14-18)

Corm laterally compressed, (7)9.5(14) mm in diameter, with a basal crest ascending by both sides of the corm; tunics brown, coriaceous, with marked nerves descending down the tunics to the renovation bud. Cataphyll membranous, white, papery in texture at senescence. Leaves distichous, ovate-lanceolate, 40-60 (200 in cultivation) x (5)15(25) mm, amplexicaule, glaucous, apex acute, margin with papillae more frequently near the apex. Bracts elliptic with similar texture to leaves, (25)42(55) x (15)22(26) mm, glaucous, apex acute, margin with a narrow white wing. Flowers sessile, 1-2 per corm, disagreeably scented; perianth 20-25 mm long; tepal's lamina lanceolate, recurved, apex obtuse, (10)13.4(17) x (7)8.3(12) mm, green, with auricles semi-transparent embracing only the filament's sides; claw (4.5)7.3(10) mm long, white with purple nerviations. Stamens semi-exserted; filaments (6)8.6(11.5) mm long, purple; anthers lanceolate, (5)7.3(10) x (2)2.5(3.5) mm, bluish-purple; nectary cylindrical, purple, twofold wider than the filament. Ovary oblong (6)7.1(8) mm long; style (7)8(9) mm long; stigma papillose, capitate, purplish. Capsule globose, dehiscent, (9)11.9(16) x (7)11.1(17) mm. Seeds globose, (1) 1.4 (1.7) mm in diameter, testa black and rough, without a developed raphe. Few idioblasts on leaves, but abundant in tepals and capsule, identifiable in the senescence as densely distributed red dots. Pollen diaperturate with microrugulate-perforate-reticulate surface sculpturing, 10.4x18.7x11.9 μ m. Species with preferential self-incompatible reproduction. Annual vegetative reproduction ends up with the formation of a little daughter corm situated near the apical bud of the mother corm. $2n=20$.

Flowering in August (December-January in J.B. Marimurtra).

Distribution: Cape Province. In Namaqualand Region, near Springbok.

Androcymbium walteri and *A. poeltianum* U.Müll.-Doblies & D.Müll.-Doblies share several morphological traits: flat corm with decurrent foldings on the surface

and a crest ascending along its sides. The tepal's length and the proportion between lamina and claw are statistically indistinguishable. In turn, the anther in *A. walteri* is semi-exsert and more than twice as long as *A. poeltianum*'s (Fig. 14, Table 4). Both species share with *A. bellum* the same vegetative propagation mode (i.e. a tiny corm that remains stuck to the mother corm under the coriaceous tunic during several years). However, they differ in other features related to sexual reproduction. *Androcymbium poeltianum* is self-compatible and has inodorous nectar, while *A. walteri* and *A. bellum* are preferentially self-incompatible and have odoriferous nectar (pestilent in the former and aromatic in the latter). Morphological similarity indicates a closer relationship of *A. poeltianum* with *A. walteri* than with *A. bellum* (Fig. 15A). On the contrary, allozymic similarity (Fig. 15B) suggests a closer relationship of *A. walteri* with *A. bellum* than with *A. poeltianum*. Allozymic identity between *A. walteri* and *A. poeltianum* is 0.808, and that between *A. walteri* and *A. bellum* is 0.875. The morphological phylogeny (Fig. 15C) groups these three species in the same clade, but allows for the possibility that *A. bellum* and *A. poeltianum* bear a closer relationship than either of them to *A. walteri*. A very different picture emerges from the cpDNA RFLP phylogeny (Fig. 15D), with *A. walteri* and *A. poeltianum* closely related phylogenetically and *A. bellum* in a distant clade. This example is illustrative of a coincidence between morphological and allozyme relationships which is not paralleled by the cpDNA RFLP phylogeny.

Species	n	LL	LF*	LA*	LE*
<i>A. walteri</i>	9	13.39±1.9	8.59±1.6	7.33±1.3	8.00±0.5
<i>A. poeltianum</i>	7	12.80±1.9	6.10±1.0	3.41±0.5	6.22±0.8

Table 4. - Mean and standard deviation for the most important characters in the differentiation of *A. walteri* and *A. poeltianum*. n: number of individuals studied. LL: tepal's lamina length, LF: filament length, LA: anther length, and LE: style length. The characters were measured in mm. Asterisks after variable codes signal significant differences between the two species at the 0.05 level.

Under a phenetic perspective, the morphological identification of all these *Androcymbium* species and subspecies is not always supported on allozymic grounds, and this is a first conflicting area between morphological and molecular data. However, the phenetic species concept underlies the assumption that a greater similarity indicates a closer phylogenetic (and therefore taxonomic) affinity. From this standpoint, species' description and justification obeys to purely mechanistic species concepts, which are untestable because of lack of universality in the criteria used.

The historical species concept is, for some authors, currently preferred on the grounds that it can be applied and tested consistently (LUCKOW, 1995). Hence, recent phylogenetic studies using parsimony methods in morphological and cpDNA RFLP databases embracing a consistent populational representation of

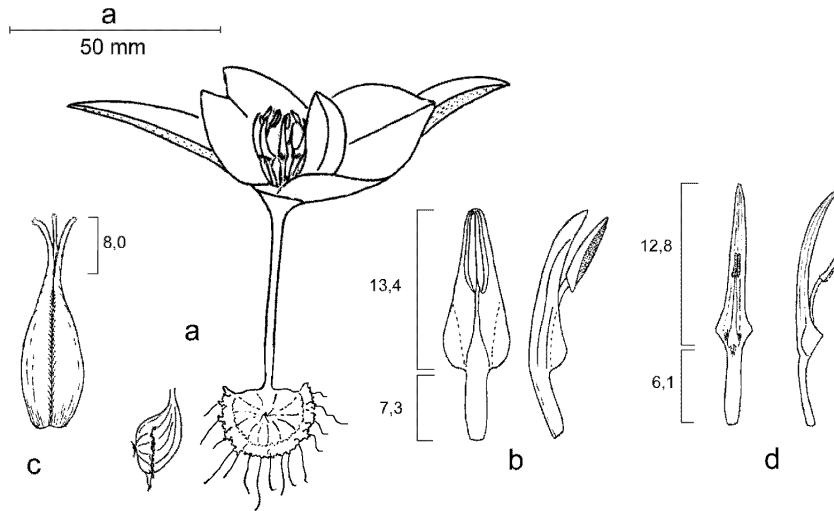

Figure 14.- *Androcymbium walteri* Pedrola, Membrives & J.M.Monts. a: Plant general view. b: tepal. c: capsule immature. d: tepal of *A. poeltianum* (measurements of b-d are expressed in mm).

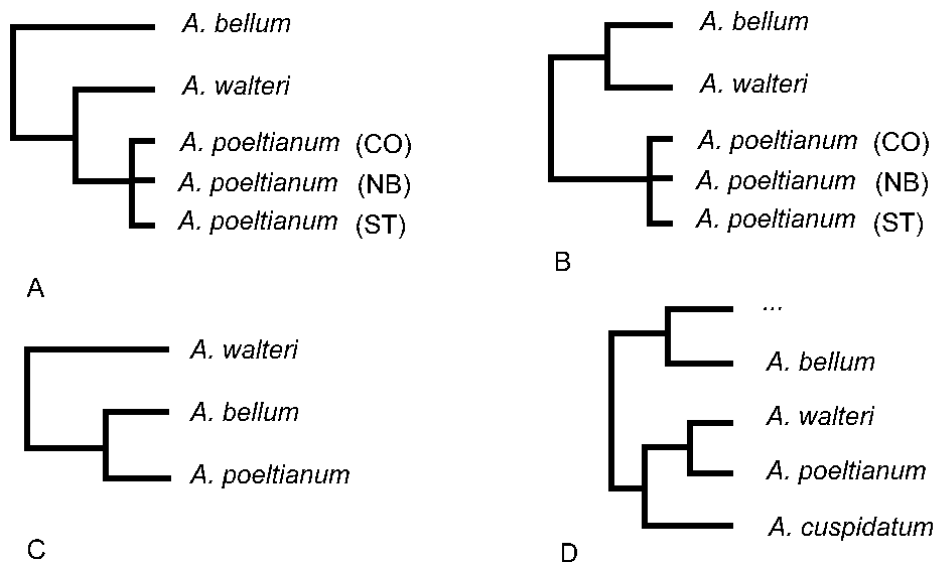
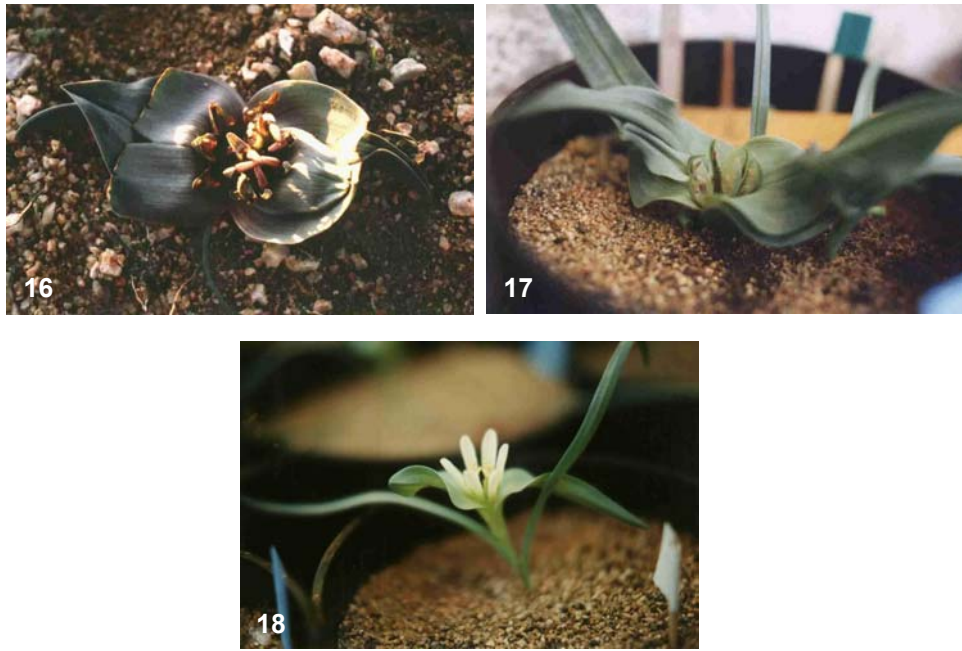

Figure 15.- Similarity relationships between *A. eghimocymbion* and *A. austrocapse* in terms of (A) morphological and (B) allozymatic data and phylogenetic relationships according to (C) morphological data and (D) cpDNA RFLPs. CO: Concordia, NB: Nababeep, ST: Steinkopf.



Figures 16-18.- *Androcymbium walteri*, from field (16). *Androcymbium poeltianum*, from cultivation (17). *Androcymbium bellum*, from cultivation (18).

Androcymbium (CAUJAPÉ-CASTELLS *et al.*, 1999b; MEMBRIVES, 2000) set the stage to test the species concept in this genus from an evolutionary standpoint. The major drawback under this scheme is that support for (phenetic) species description comes from phylogenetic hypotheses. Because of their different philosophical contexts and purposes, conclusions reached at each of these two analytical levels might conflict.

If we consider that the topologies tracking the changes in the chloroplast genome and in morphological traits are reflecting true genealogical relationships, the problem lies in deciding whether we can assert that these species are different entities phylogenetically. Stated in other terms, would they be within the smaller diagnosable units (CRACRAFT, 1983; NIXON & WHEELER, 1990) ? It is difficult at this point to be precise at distinguishing the species as a minimum diagnosable unit, and this has implications at the sampling (a comprehensive populational sampling is required) and analytical (we need to survey several different molecular markers) levels.

The analysis of a comprehensive sampling of populations under different morphological and molecular markers to obtain the smaller diagnosable units is not always possible. Bearing this in mind, we can compare this difficulty with that deriving from the application of other generally used species concepts (i. e. the biological species concept) where experimental work is also arduous often times.

ACKNOWLEDGEMENTS

Amparo Ardanuy provided for the well being and conservation of the cultured material. Jordi Gibert gave insightful suggestions to an earlier version of the manuscript. The expeditions of sampling of the material in culture and the studies of conservation genetics developed at the "Estació Internacional de Biologia Mediterrània-Jardí Botànic Marimurtra" have been supported and funded by the Karl Faust Foundation. The cpDNA RFLP study was funded by Juli Caujapé-Castells while he was a recipient of the post-doctoral grant 1996BEAI300012 from the Generalitat de Catalunya.

REFERENCES

- ARNOLD, T. H. & B. C. WET, 1993.- Plants of Southern Africa: names and distribution. *Nacional Botanic Institute Memoir.*, 62: 31.
- CAUJAPÉ-CASTELLS, J. & J. PEDROLA-MONFORT, 1997.- Space-time patterns of genetic structure within a stand of *Androcymbium gramineum* (Cav.) McBride (Colchicaceae) *Heredity*, 79: 341-349.
- J. PEDROLA-MONFORT & N. MEMBRIVES, 1999a.- Contrasting patterns of genetic structure in the South African species *Androcymbium bellum*, *A. guttatum* and *A. pulchrum* (Colchicaceae) Pergamon. *Biochemical Systematics and Ecology*, 27: 591-605.
- R. K. JANSEN, J. PEDROLA-MONFORT & N. MEMBRIVES, 1999b.- Chloroplast DNA Restriction Site Phylogeny of the Genus *Androcymbium* (Colchicaceae) *Syst. Bot.*, 24(4): 581-597.
- CRACRAFT, J., 1983.- Species concepts and speciation analysis. *Current Ornithology* 1: 159-187.
- CRAWFORD, D. J., 1990.- *Plant molecular Systematics. Macromolecular Approaches*. Ed. John Wiley & Son. New York.
- GOLOBOFF, P. A., 1993.- NONA Version 2.0 for Windows.
- GOTTLIEB, L. D., 1981.- Electrophoretic Evidence and Plant poblacions. *Progress in Phytochemistry*, 7: 1-46.
- HOLMGREN, P. K., N. H. HOLMGREN & L. C. BARNETT, 1990.- "*Index Herbariorum*" Eighth Edition. New York Botanical Garden, New York.
- LUCKOW, M., 1995.- Species concepts: assumptions, methods, and applications. *Syst. Bot.*, 29 (4): 589-605.
- MEMBRIVES, N., 2000.- *Biologia evolutiva del gènere Androcymbium (Colchicaceae) a Sudàfrica Occidental*. Tesis Doctoral. Universitat de Barcelona.
- MÜLLER-DOBLIES, U. & D. MÜLLER-DOBLIES, 1998.- De Liliifloris Notulae. 6. De decuria prima specierum novarum generis *Androcymbium* sect. *Androcymbium* (Colchicaceae) in Africa Australi s.l. Praeterea novitates de huius sectionis nonnullarum specierum distributione (praesertim aucta speciminibus STEllenbosensibus i.a. collectis a botanico vero E. G. H. OLIVERO) *Fedd. Reper.*, 109 (7-8): 551-572.
- NEI, M., 1978.- Estimation of average heterozygosity and genetic distance from a small number of individuals. *Genetics*, 89: 583-590.
- NIXON, K. C. & Q. D. WHEELER, 1990.- An amplification of the phylogenetic species concept. *Cladistics*, 6: 211-223.
- PEDROLA-MONFORT, J. & J. CAUJAPÉ-CASTELLS (1994) Allozymic and morphological relationships among *Androcymbium gramineum*, *A. europaeum*, and *A. psammophilum* (Colchicaceae). *Plant Systematics and Evolution* 191: 111-126.
- PEDROLA-MONFORT, J. & J. CAUJAPÉ-CASTELLS, 1995.- Genetic structure and spatial distribution of a narrow endemic plant: *Androcymbium europaeum* (Lange) K. Richter (Colchicaceae). *Bot. Macaronésica*, 21: 85-94.

- PEDROLA-MONFORT, J. & J. CAUJAPÉ-CASTELLS, 1996.- Genetic and morphological divergence in the *Androcymbium gramineum* complex (Colchicaceae). *Plant Systematics and Evolution*, 201:149-162.
- PEDROLA-MONFORT, J. & J. CAUJAPÉ-CASTELLS, 1998.- The *Androcymbium* species of the Canary Islands. *Curtis's Botanical Magazine*, 15 (1): 67-77.
- PEDROLA-MONFORT, J., N. MEMBRIVES, J. M. MONTSERRAT & J. CAUJAPÉ-CASTELLS, 1999a.- A new species from the Western of South Africa: *Androcymbium huntleyi* (Colchicaceae) *Fontqueria*, 53: 1-2.
- PEDROLA-MONFORT, J., N. MEMBRIVES & J. M. MONTSERRAT, 1999b.- Two new *Androcymbia* (Colchicaceae) from Western South Africa. *Fontqueria*, 54(2): 7-9.
- ROHLF, F. J., 1992.- *NTSYS-pc, numerical taxonomy and multivariate analysis system*. Stauket: Exeter software.
- STUESSY, T. F., 1990.- *Plant Taxonomy*. Columbia University Press. New York.
- SWOFFORD, D. L. & R. B. SELANDER, 1989.- *BIOSYS-1, a computer program for the analysis of genetic variation in populational genetic and biochemical systematics, version 1.7*. Champaign: Illinois Natural History Survey.
- WILLDENOW, C. L., 1808.- Einiger: Liliengewäusche. *Gesellschaft Naturforschender Freunde zu Berlin. Magazin für die Neusten Entdeckungen in der Gesamten Naturkunde*, 2 (2): 21-24.

Appendix. Examined material (Abbreviations of the herbariums according to HOLMGREN *et al.*, 1990).

A. austrocapense.- SOUTHAFRICA.- Western Cape: Caledon, Kleinimond (3419AB), 15-X-1949, A.F. 969 (NBG); Caledon, Kogel Bay (3419CA), 2-VIII-1946, W.F. Parker 4088 (NBG); Caledon, Hangklip (3419CA), 6-IX-1942, R.H. Compton 13574 (NBG); Wilderness dunes, George C.P., 16-VIII-1944, R. H. Compton 15755 (NBG); Simonstown, Red Hill (3418AB), 18-VII-1903, E.P. Phillips 349 (NBG); Simonstown (3418AB), 1-VII-1993, C. Martins 18892 (J); Simonstown, Good Hope (3418AC), 17-VII-1994, *Pedrola-Monfort & Caujapé-Castells* (NBG 153704), (Jardí Botànic Marimurtra 1371), *in culta* (Jardí Botànic Marimurtra); Simonstown, Whale's Point (3418AD), 17-VII-1994, *Pedrola-Monfort & Caujapé-Castells* (Jardí Botànic Marimurtra 1370), *in culta* (Jardí Botànic Marimurtra); Wilderness (3422BA), 16-VIII-1944, R.H. Compton 74303 (NBG).- Eastern Cape: SW of Port Elizabeth (3425AB), 30-VIII-1981, D. Snijman 123278 (NBG); Cape Recife Natural Reserve, VIII-1983, M. C. Oliver (MO 3157944).

A. burchellii.- SOUTHAFRICA. – Northern Cape: Anysberg Nature Reserve, Farm Kleinspreuwfontein 177 (3320BC), 3000 ft. 27-VIII-1987, J.W. Lloyd 1056 (NBG); Laingsburg C.P., Whitehill (3320BB), 17-VIII-1942, R.H. Compton 13399 (NBG); Nieuwoudtville, farm Matjesfontein (3119AC), 23-VIII-1993, P. Goldblatt & J. Manning 9641 (NBG); Sutherland, Houthoek (3220CA), 31-VIII-1971, W.J. Hanekom 1550 (NBG); Tangua Karoo (3220DA), 31-VIII-1921, R. Marloth 10374 (NBG); Tangua Karoo (3220DA), IX-1921, R. Marloth 10374 (B); Houthoek (3220CA), 31-VIII-1971, W.J. Hanekom 1550 (K); Sutherland, Koedoes Mountains (3220CC), 21-IX-1981, P. Goldblatt 6307 (MO); Worcester (3319BC), 24-VII-1994, *Pedrola-Monfort & Caujapé-Castells* (Jardí Botànic Marimurtra 1368), *in culta* (Jardí Botànic Marimurtra).

A. eghimocymbion.- SOUTHAFRICA. – Western Cape: Cape Town, Paarl Mountain (3318DB), 500 ft. 28-VII-1961, I. Kruger M19 (NBG); Helderberg, Stellenbosch C.P. (3418BB), 240 m., 6-VIII-1944, R.H. Parker 3897 (NBG); Cape Peninsula. Botlaryberg, on farm Koopmanskloof (3318DD), 1500 ft. 13-IX-1988, J. Beyers 71 (NBG); Wuppertal, Pakhuispass, 10 km from Clanwilliam (3219AA), 8-VIII-1994, *Pedrola-Monfort & Caujapé-Castells* (NBG 153709); Simonstown, Somerset West (3418 BB), 13-VIII-1995, P. Runnalls 813 (NBG); Cape Peninsula. VIII-1950, Pillans 10570 (MO); Citrusdal (3218DB), 8-VIII-1994, *Pedrola-Monfort & Caujapé-Castells* (Jardí Botànic Marimurtra 1395), *in culta* (Jardí Botànic Marimurtra); Wuppertal (3219AA), 8-VIII-1994, *Pedrola-Monfort & Caujapé-Castells in culta* (Jardí Botànic Marimurtra).

A. henssenianum.- SOUTHAFRICA. – Northern Cape: Vioolsdrift, 2 km N of Eksteenfontein, before the turn off to Modderfontein (2817CD), 10-VIII-1979, U.Müll.-Doblies & D.Müll.-Doblies 79177a (B); Vioolsdrift (2817CC), 4-VIII-1994, *Pedrola-Monfort & Caujapé-Castells in culta* (Jardí Botànic Marimurtra).

A. huntleyi.- SOUTHAFRICA.- Northern Cape: Vioolsdrift, Road to Eksteenfontein (2917CD), 24-VIII-1992, P. Goldblatt & J. Manning 9313 (MO); 20 km S of Eksteenfontein (2917AD), 4-VIII-1994, *Pedrola-Monfort & Caujapé-Castells* (BC 834977), *in culta* (Jardí Botànic Marimurtra).

A. latifolium.- SOUTHAFRICA.- Northern Cape: Calvinia (3119BD), 25-VIII-1968, F. Stayner (NBG 87514); Nieuwoudtville, Farm Oorlogskloof near Nieuwoudtville (3118BB), 10-VIII-1983, C.M. van Wyk 1418 (NBG); Klip Koppies, Nieuwoudtville (3118BB), 9-VIII-1961, S.G. Lenis 5863 (NBG); 5 miles S of Calvinia (3119BC), 21-VII-1961, W.F. Barker 9303 (NBG); Nieuwoudtville (3118BB), undated, C.L. Leifoldt H1425/98-67 (K); Oorlogskloof, 21-VIII-1897, Schlechter 10953 (B,COI,MO); Nieuwoudtville (3119AA), 27-VII-1994, *Pedrola-Monfort & Caujapé-Castells* (Jardí Botànic Marimurtra 1384), *in culta* (Jardí Botànic Marimurtra); Calvinia (3119DA), 27-VII-1994, *Pedrola-Monfort & Caujapé-Castells* (Jardí Botànic Marimurtra 1385), *in culta* (Jardí Botànic Marimurtra).- Western Cape: Rusoord, N de Sutherland (3220AD), 2-IX-1973, M.F. Thompson, 1795 (NH).

A. poeltianum.- SOUTHAFRICA. – Northern Cape: Concordia. NE of the settlement (2917DB), Alt. 1050 m. 15-VIII-1980, U.Müll.-Doblies & D.Müll.-Doblies 80102j (B); Springbok to Nababeep Road (2917DB), 6-VIII-1994, *Pedrola-Monfort & Caujapé-Castells* (Jardí Botànic Marimurtra 1376), *in culta* (Jardí Botànic Marimurtra.); Springbok to Concordia Road (2917DB), 6-VIII-1994, *Pedrola-Monfort & Caujapé-Castells* (Jardí Botànic Marimurtra 1377), *in culta* (Jardí Botànic Marimurtra); 5 km from Steinkopf to Springbok (2917DC), 3-VIII-1994, *Pedrola-Monfort & Caujapé-Castells in culta* (Jardí

Botànic Marimurtra).

A. walteri.- SOUTHAFRICA.- Northern Cape: Steinkopf (2917DC), 3-VIII-1994, *Pedrola-Monfort & Caujapé-Castells* (BC 834975); Steinkopf (2917DC), 3-VIII-1994, *Pedrola-Monfort & Caujapé-Castells* (Jardí Botànic Marimurtra 1380), *in culta* (Jardí Botànic Marimurtra).

-. NAMIBIA: Witputz, across 21 km top of hill, Down 9,36 km (2716DA), 12-VII-1983, *N.J. van Berkel* 498 (NBG).