

Appendix A: Public Consultation Documents

- 1. Newspaper adverts**
- 2. Consultation Register**
- 3. Questionnaire**
- 4. Communiques**



**NOTIFICATION AND CALL FOR PUBLIC PARTICIPATION
ENVIRONMENTAL IMPACT ASSESSMENT (EIA) PROCESS FOR THE PROPOSED DEVELOPMENT OF 22
TELECOMMUNICATION BASE-TRANSCIVER STATION (BTS) TOWERS ON SELECTED SITES COUNTRYWIDE, NAMIBIA**

D & P Engineers and Environmental Consultants hereby gives notice to all potentially interested and Affected Parties (I&AP) that an application will be made to the Environmental Commissioner in terms of the Environmental Management Act (No 7 of 2007) and the Environmental Impact Assessment Regulations (GN 30 of 6 February 2012) for the proposed development of twenty two (22) base transceiver station (BTS) towers.

Powercom (PTN) LTD herein referred to as the proponent has identified different areas that needs improved communication alternatives in Namibia due to growth in population and economic activities. To achieve the objective of improved telecommunication connectivity, Powercom has been appointed by Telecom Namibia's sister company to establish telecommunication towers across the identified different locations. In this respect, Powercom has identified sites to construct and operate 22 telecommunication base transceiver station towers across the country.

Powercom (the proponent) has appointed D&P Engineers and Environmental Consultants to conduct the EIA process for these proposed BTS tower developments. The EIA is being conducted to satisfy the Namibian environmental legislative requirements. The general public as well as any interested and Affected Parties (I&AP) are hereby invited to register their concerns and notify the consultant of any potential environmental and social impacts that may be triggered by the project.

The proposed projects for which the Environmental Clearance Certificates will be applied for are as follows:

<p>1. Project Title: Environmental Impact Assessment (EIA) Study for the Proposed Construction and Operation of a Telecommunication Base Transceiver Station (BTS) Tower at Seehelm Settlement in Eraras Region.</p> <p>Location: Seehelm Settlement, Eraras Region - Namibia</p> <p>Coordinates: 26°49'02.8"S, 17°48'11.5"E</p>	<p>2. Project Title: Environmental Impact Assessment (EIA) Study for the Proposed Construction and Operation of a Telecommunication Base Transceiver Station (BTS) Tower at Ohango Village in Oshana Region.</p> <p>Location: Ohango Village, Oshana Region - Namibia</p> <p>Coordinates: 18°02'21.8"S 16°19'24.7"E</p>	<p>Project Title: Environmental Impact Assessment (EIA) Study for the Proposed Construction and Operation of a Telecommunication Base Transceiver Station (BTS) Tower at Otshandja Village in Oshana Region.</p> <p>Location: Otshandja Village in Oshana Region - Namibia</p> <p>Coordinates: 17°59'28.0"S 15°38'17.3"E</p>	<p>Project Title: Environmental Impact Assessment (EIA) Study for the Proposed Construction and Operation of a Telecommunication Base Transceiver Station (BTS) Tower at Otshokolo Village in, Omusati Region.</p> <p>Location: Otshokolo Village in, Omusati Region - Namibia</p> <p>Coordinates: 17°32'15.9"S 15°07'42.2"E</p>
<p>Project Title: Environmental Impact Assessment (EIA) Study for the Proposed Construction and Operation of a Telecommunication Base Transceiver Station (BTS) Tower at Ovahehene Border Post, Omusati Region.</p> <p>Location: Ovahehene Border Post, Omusati Region - Namibia</p> <p>Coordinates: 17°25'05.0"S 14°34'07.8"E</p>	<p>Project Title: Environmental Impact Assessment (EIA) Study for the Proposed Construction and Operation of a Telecommunication Base Transceiver Station (BTS) Tower at Epanga Village, Oshana Region.</p> <p>Location: Epanga Village, Oshana Region - Namibia</p> <p>Coordinates: 17°24'37.5"S 16°26'14.7"E</p>	<p>Project Title: Environmental Impact Assessment (EIA) Study for the Proposed Construction and Operation of a Telecommunication Base Transceiver Station (BTS) Tower at Mupini Village in, Kavango West Region.</p> <p>Location: Mupini Village in, Kavango West Region - Namibia</p> <p>Coordinates: 17°52'48.6"S 19°37'52.4"E</p>	<p>Project Title: Environmental Impact Assessment (EIA) Study for the Proposed Construction and Operation of a Telecommunication Base Transceiver Station (BTS) Tower at Kangongo Village in, Kavango East Region.</p> <p>Location: Kangongo Village in, Kavango East Region - Namibia</p> <p>Coordinates: 17°57'01.7"S 21°09'52.5"E</p>
<p>Project Title: Environmental Impact Assessment (EIA) Study for the Proposed Construction and Operation of a Telecommunication Base Transceiver Station (BTS) Tower at Gulnas, Oshana Region.</p> <p>Location: Gulnas, Oshana Region - Namibia</p> <p>Coordinates: 20°14'52.4"S 17°20'53.9"E</p>	<p>Project Title: Environmental Impact Assessment (EIA) Study for the Proposed Construction and Operation of a Telecommunication Base Transceiver Station (BTS) Tower at Hamuse Village in, Zambezi Region.</p> <p>Location: Hamuse Village, Zambezi Region - Namibia</p> <p>Coordinates: 17°47'28.8"S 24°36'56.9"E</p>	<p>Project Title: Environmental Impact Assessment (EIA) Study for the Proposed Construction and Operation of a Telecommunication Base Transceiver Station (BTS) Tower at Dobra Brakwater in, Eraras Region.</p> <p>Location: Dobra Brakwater in, Eraras Region - Namibia</p> <p>Coordinates: 22°57'07.1"S 17°05'37.6"E</p>	<p>Project Title: Environmental Impact Assessment (EIA) Study for the Proposed Construction and Operation of a Telecommunication Base Transceiver Station (BTS) Tower at Howobees 51 in, Eraras Region.</p> <p>Location: Howobees Settlement, Eraras Region - Namibia</p> <p>Coordinates: 26°48'02.9"S, 17°48'11.5"E</p>
<p>Project Title: Environmental Impact Assessment (EIA) Study for the Proposed Construction and Operation of a Telecommunication Base Transceiver Station (BTS) Tower at Uyoeka village, Oshana Region.</p> <p>Location: Uyoeka village, Oshana Region - Namibia</p> <p>Coordinates: 17°57'24.7"S 16°18'39.1"E</p>	<p>Project Title: Environmental Impact Assessment (EIA) Study for the Proposed Construction and Operation of a Telecommunication Base Transceiver Station (BTS) Tower at Uunavuya Village in, Oshana Region.</p> <p>Location: Uunavuya Village in, Oshana Region - Namibia</p> <p>Coordinates: 18°08'05.7"S 15°27'53.3"E</p>	<p>Project Title: Environmental Impact Assessment (EIA) Study for the Proposed Construction and Operation of a Telecommunication Base Transceiver Station (BTS) Tower at Nakajale Anamulenge Village in, Omusati Region.</p> <p>Location: Nakajale Anamulenge Village in, Omusati Region - Namibia</p> <p>Coordinates: 17°29'41.0"S 15°00'51.0"E</p>	<p>Project Title: Environmental Impact Assessment (EIA) Study for the Proposed Construction and Operation of a Telecommunication Base Transceiver Station (BTS) Tower at Okupundu Village in, Omusati Region.</p> <p>Location: Okupundu Village in, Omusati Region - Namibia</p> <p>Coordinates: 17°34'05.9"S 15°36'25.6"E</p>
<p>Project Title: Environmental Impact Assessment (EIA) Study for the Proposed Construction and Operation of a Telecommunication Base Transceiver Station (BTS) Tower at Tandoro Settlement in, Kavango West Region.</p> <p>Location: Tandoro Settlement in, Kavango West Region - Namibia</p> <p>Coordinates: 17°48'13.6"S 16°47'28.5"E</p>	<p>Project Title: Environmental Impact Assessment (EIA) Study for the Proposed Construction and Operation of a Telecommunication Base Transceiver Station (BTS) Tower at Nlonga Liensa Settlement in Kavango East Region.</p> <p>Location: Nlonga Liensa Settlement in Kavango East Region - Namibia</p> <p>Coordinates: 17°57'06.8"S 20°28'12.6"E</p>	<p>Project Title: Environmental Impact Assessment (EIA) Study for the Proposed Construction and Operation of a Telecommunication Base Transceiver Station (BTS) Tower at Oiyogha Settlement in, Kavango East Region.</p> <p>Location: Oiyogha Settlement in, Kavango East Region - Namibia</p> <p>Coordinates: 18°05'14.6"S 21°28'15.4"E</p>	<p>Project Title: Environmental Impact Assessment (EIA) Study for the Proposed Construction and Operation of a Telecommunication Base Transceiver Station (BTS) Tower at Nakohelewa Village in, Zambezi Region.</p> <p>Location: Nakohelewa Village in, Zambezi Region - Namibia</p> <p>Coordinates: 17°49'23.7"S 24°50'11.0"E</p>
<p>Project Title: Environmental Impact Assessment (EIA) Study for the Proposed Construction and Operation of a Telecommunication Base Transceiver Station (BTS) Tower at Muliwila Village in Zambezi Region.</p> <p>Location: Muliwila Village in Zambezi Region - Namibia</p> <p>Coordinates: 17°55'40.4"S 24°37'42.0"E</p>	<p>Project Title: Environmental Impact Assessment (EIA) Study for the Proposed Construction and Operation of a Telecommunication Base Transceiver Station (BTS) Tower at Walvis Bay Extension 17 in, Erongo Region.</p> <p>Location: Walvis Bay Extension 17 in, Erongo Region - Namibia</p> <p>Coordinates: To be Confirmed</p>		

Contact Details: D&P Engineers and Environmental Consultants
Attention: Mr. I Kasipaneli
PO Box 8401, Windhoek, Namibia
Email: ikasp@dnpe.com.na
Tel: +264 61 902672

Interested & Affected Parties (I&AP) Registration and submission of comments: To comment or receive further information on the project, please register with the consultant (contact details below) as an I&AP before end of business on 25 September 2022. A Background Information Document (BID) has been compiled for the project and is available upon request to the consultant, contact below.

All registered I&APs will be informed throughout the assessment process and will be provided with further opportunities for review and submission of comments. Comments can also be lodged via the online form given:

<https://forms.gle/P9KCoabnQ9u6G6w>

Adopt, Don't Shop!

HELLO!

They call me **RAFIKI**

10 TO 12 WEEKS OLD FEMALE DOG

For happy, wonderful, and fun times!



Rafiki, is a 10 months old female dog. My name means friend, in Kiswahili and best believe I live up to my name, once I've grown fond of my human and have built a bond, I enjoy average physical exercise, and I have a short easy-care coat. I know how to sit, and I walk really well on a leash. I am partially house trained. I would appreciate a home that allows me to sleep indoors for that is what I am accustomed to.

HELLO!

They call me **HUNTER**

3 YEAR OLD MALE CAT

For happy, wonderful, and fun times!



Hunter a 2-year-old male cat looking for his purrfect home. He is an easy-going cat, that enjoys the attention and affection he gets from humans. Hunter will thrive in a home with other cats.



SPCA Windhoek
145 Robert Mugabe Avenue,
Windhoek
Tel: 061-238 654
Emergency Cell: 081-124 4520
(After Hours Only)
Email: info@spcawindhoek.org.na



NOTIFICATION AND CALL FOR PUBLIC PARTICIPATION
ENVIRONMENTAL IMPACT ASSESSMENT (EIA) PROCESS FOR THE PROPOSED DEVELOPMENT OF 22 TELECOMMUNICATION BASE-TRANSCIVER STATION (BTS) TOWERS ON SELECTED SITES COUNTRYWIDE, NAMIBIA

D & P Engineers and Environmental Consultants hereby gives notice to all potentially interested and Affected Parties (I&AP) that an application will be made to the Environmental Commissioner in terms of the Environmental Management Act (No. 7 of 2007) and the Environmental Impact Assessment Regulations (GN 30 of 6 February 2012) for the proposed development of twenty two (22) base transceiver station (BTS) towers.

Powercom (PTY) LTD herein referred to as the proponent has identified different areas that needs improved communication alternatives in Namibia due to growth in population and economic activities. To achieve the objective of improved telecommunication connect with, Powercom has been appointed by Telecom Namibia its sister company to establish telecommunication towers across the identified different locations. In this respect, Powercom has identified sites to construct and operate 22 telecommunication base transceiver station towers across the country.

Powercom (the proponent) has appointed D & P Engineers and Environmental Consultants to conduct the EIA processes for these proposed BTS tower developments. The EIA is being conducted to satisfy the Namibian environmental legislative requirements. The general public as well as any interested and Affected Parties (I&AP) are hereby invited to register their concerns and notify the consultant of any potential environmental and social impacts that may be triggered by the project.

The proposed projects for which the Environmental Clearance Certificates will be applied for are as follows:

<p>1. Project Title: Environmental Impact Assessment (EIA) Study for the Proposed Construction and Operation of a Telecommunication Base Transceiver Station (BTS) Tower at Sechem Settlement, Erongo Region.</p> <p>Location: Sechem Settlement, Erongo Region - Namibia</p> <p>Coordinates: 26°49'02.3" S, 17°48'11.9" E</p>	<p>2. Project Title: Environmental Impact Assessment (EIA) Study for the Proposed Construction and Operation of a Telecommunication Base Transceiver Station (BTS) Tower at Lihongo Village in, Oshana Region.</p> <p>Location: Lihongo Village, Oshana Region - Namibia</p> <p>Coordinates: 18°02'21.8" S 16°10'34.7" E</p>	<p>Project Title: Environmental Impact Assessment (EIA) Study for the Proposed Construction and Operation of a Telecommunication Base Transceiver Station (BTS) Tower at Otshandjo Village in Oshana Region - Namibia</p> <p>Location: Otshandjo Village in Oshana Region - Namibia</p> <p>Coordinates: 17°49'28.0" S 15°58'17.1" E</p>	<p>Project Title: Environmental Impact Assessment (EIA) Study for the Proposed Construction and Operation of a Telecommunication Base Transceiver Station (BTS) Tower at Onkoko Village in, Omusati Region - Namibia</p> <p>Location: Onkoko Village in, Omusati Region - Namibia</p> <p>Coordinates: 17°32'15.3" S 15°07'42.2" E</p>
<p>Project Title: Environmental Impact Assessment (EIA) Study for the Proposed Construction and Operation of a Telecommunication Base Transceiver Station (BTS) Tower at Oshahene Border Post, Omusati Region - Namibia</p> <p>Location: Oshahene Border Post, Omusati Region - Namibia</p> <p>Coordinates: 17°25'05.0" S 14°54'07.0" E</p>	<p>Project Title: Environmental Impact Assessment (EIA) Study for the Proposed Construction and Operation of a Telecommunication Base Transceiver Station (BTS) Tower at Eronga village, Erongo Region.</p> <p>Location: Springs village, Erongo Region - Namibia</p> <p>Coordinates: 17°28'37.9" S 16°26'34.7" E</p>	<p>Project Title: Environmental Impact Assessment (EIA) Study for the Proposed Construction and Operation of a Telecommunication Base Transceiver Station (BTS) Tower at Mugini Village in, Karas West Region.</p> <p>Location: Mugini Village in, Karas West Region - Namibia</p> <p>Coordinates: 17°52'48.8" S 15°57'52.4" E</p>	<p>Project Title: Environmental Impact Assessment (EIA) Study for the Proposed Construction and Operation of a Telecommunication Base Transceiver Station (BTS) Tower at Kangango Village in, Karas East Region.</p> <p>Location: Kangango Village in, Karas East Region - Namibia</p> <p>Coordinates: 17°57'01.7" S 15°09'52.5" E</p>
<p>Project Title: Environmental Impact Assessment (EIA) Study for the Proposed Construction and Operation of a Telecommunication Base Transceiver Station (BTS) Tower at Ganas, Oshana Region - Namibia</p> <p>Location: Ganas, Oshana Region - Namibia</p> <p>Coordinates: 18°14'52.4" S 17°20'55.3" E</p>	<p>Project Title: Environmental Impact Assessment (EIA) Study for the Proposed Construction and Operation of a Telecommunication Base Transceiver Station (BTS) Tower at Isuarua Village in, Zambezi Region - Namibia</p> <p>Location: Isuarua Village, Zambezi Region - Namibia</p> <p>Coordinates: 17°47'28.3" S 14°36'46.9" E</p>	<p>Project Title: Environmental Impact Assessment (EIA) Study for the Proposed Construction and Operation of a Telecommunication Base Transceiver Station (BTS) Tower at Dobsa Brookwater in, Erongo Region - Namibia</p> <p>Location: Dobsa Brookwater in, Erongo Region - Namibia</p> <p>Coordinates: 22°52'07.1" S 17°05'37.6" E</p>	<p>Project Title: Environmental Impact Assessment (EIA) Study for the Proposed Construction and Operation of a Telecommunication Base Transceiver Station (BTS) Tower at Nowobes Settlement, Erongo Region - Namibia</p> <p>Location: Nowobes Settlement, Erongo Region - Namibia</p> <p>Coordinates: 26°49'02.3" S, 17°48'11.9" E</p>
<p>Project Title: Environmental Impact Assessment (EIA) Study for the Proposed Construction and Operation of a Telecommunication Base Transceiver Station (BTS) Tower at Uuyoka village, Oshana Region - Namibia</p> <p>Location: Uuyoka village, Oshana Region - Namibia</p> <p>Coordinates: 17°57'34.7" S 16°16'39.1" E</p>	<p>Project Title: Environmental Impact Assessment (EIA) Study for the Proposed Construction and Operation of a Telecommunication Base Transceiver Station (BTS) Tower at Uuuviva Village in, Oshana Region - Namibia</p> <p>Location: Uuuviva Village in, Oshana Region - Namibia</p> <p>Coordinates: 18°08'05.7" S 15°27'35.3" E</p>	<p>Project Title: Environmental Impact Assessment (EIA) Study for the Proposed Construction and Operation of a Telecommunication Base Transceiver Station (BTS) Tower at Namakaya Anamulenge Village in, Omusati Region - Namibia</p> <p>Location: Namakaya Anamulenge Village in, Omusati Region - Namibia</p> <p>Coordinates: 17°28'41.0" S 15°00'51.0" E</p>	<p>Project Title: Environmental Impact Assessment (EIA) Study for the Proposed Construction and Operation of a Telecommunication Base Transceiver Station (BTS) Tower at Oupandjo Village in, Omusati Region - Namibia</p> <p>Location: Oupandjo Village in, Omusati Region - Namibia</p> <p>Coordinates: 17°34'05.9" S 15°16'35.0" E</p>
<p>Project Title: Environmental Impact Assessment (EIA) Study for the Proposed Construction and Operation of a Telecommunication Base Transceiver Station (BTS) Tower at Tondoro Settlement in, Karas West Region - Namibia</p> <p>Location: Tondoro Settlement in, Karas West Region - Namibia</p> <p>Coordinates: 17°40'17.6" S 15°47'28.3" E</p>	<p>Project Title: Environmental Impact Assessment (EIA) Study for the Proposed Construction and Operation of a Telecommunication Base Transceiver Station (BTS) Tower at Hinganga Linosa Settlement in, Erongo East Region - Namibia</p> <p>Location: Hinganga Linosa Settlement in, Erongo East Region - Namibia</p> <p>Coordinates: 17°57'08.8" S 16°28'12.0" E</p>	<p>Project Title: Environmental Impact Assessment (EIA) Study for the Proposed Construction and Operation of a Telecommunication Base Transceiver Station (BTS) Tower at Ganga Settlement in, Karas East Region.</p> <p>Location: Ganga Settlement in, Karas East Region - Namibia</p> <p>Coordinates: 18°01'14.8" S 17°28'15.4" E</p>	<p>Project Title: Environmental Impact Assessment (EIA) Study for the Proposed Construction and Operation of a Telecommunication Base Transceiver Station (BTS) Tower at Namakobwa Village in, Zambezi Region - Namibia</p> <p>Location: Namakobwa Village in, Zambezi Region - Namibia</p> <p>Coordinates: 17°40'23.7" S 14°56'11.0" E</p>
<p>Project Title: Environmental Impact Assessment (EIA) Study for the Proposed Construction and Operation of a Telecommunication Base Transceiver Station (BTS) Tower at Mulkibia Village in Zambezi Region - Namibia</p> <p>Location: Mulkibia Village in Zambezi Region - Namibia</p> <p>Coordinates: 17°55'40.4" S 14°57'42.0" E</p>	<p>Project Title: Environmental Impact Assessment (EIA) Study for the Proposed Construction and Operation of a Telecommunication Base Transceiver Station (BTS) Tower at Waias Bay Extension 17 in, Erongo Region - Namibia</p> <p>Location: Waias Bay Extension 17 in, Erongo Region - Namibia</p> <p>Coordinates: To be confirmed</p>		

Contact Details: D&P Engineers and Environmental Consultants
Attention: Mr. T. Kaaligand
PO Box 8401, Windhoek, Namibia
Email: tdp@tdpna.com.na
Tel: +264 61 302672

Interested & Affected Parties (I&AP) Registration and submission of comments: To comment or receive further information on the project, please register with the consultant (contact details below) as an I&AP before end of business on 25 September 2022. A Background Information Document (BID) has been compiled for the project and is available upon request to the consultant, contact below.

All registered I&APs will be informed throughout the assessment process and will be provided with further opportunities for review and submission of comments. Comments can also be lodged via the online form given:
<https://forms.gle/7NkCubnQm8u8dR>



HOME LOAN INVESTMENT CC
Reg. cc: 2009/0449

P.O. BOX 2028, Groutboschen
Tel: 067-240 210
Cell: +264 81 249 1923
Email: home loan@mls.com.na

NB: We are inviting our new clients to register and qualify to be given loans within a period of 48 working hours, we offer the minimum loan amount of N\$5,000.00 to maximum amount N\$250,000.00 to private individuals, both employed and unemployed persons are welcome to register for a loan, in order to register clients should have the following documents:

- Membership registration fee of N\$150.00 (COMPULSARY) advantage:
 - Identity document, source card, passport, driver's license.
 - Latest pay slip, 3 months bank statement.
- NOTE: Approval in 48 working hours period to arrange to pay back the loan between 18-48 months.
- Please take note: Backlog clients or C/C record are acceptable on reasonable verifiable condition.

Home Loan Investment CC is pleased to inform our valuable clients that telephonically consultation, application to clients are acceptable and convenient will be provided by Home Loan Investment CC and available before approval to complete and professional service.

CONTACT THE DIRECTOR
Mr Nicco at Groutboschen main branch at Orpen/M&E Complex
Office Hours: MON-FRI 08H00 to 16H30
TELE: 067 240 210 / CELL: 081 4912 89623
FAX: 067 243 436 | Email: home loan@mls.com.na

WANT TO ADVERTISE?

Email: sales@observer.com.na
marketing@observer.com.na

CLASSIFIEDS



Rafiki, is a 10 months old female dog. My name means friend, in Kiswahili and best believe I live up to my name, once I've grown fond of my human and have built a bond, I enjoy average physical exercise, and I have a short easy-care coat. I know how to sit, and I walk really well on a leash. I am partially house trained. I would appreciate a home that allows me to sleep indoors for that is what I am accustomed to.



Hunter a 2-year-old male cat looking for his purrfect home. He is an easy going cat, that enjoys the attention and affection he gets from humans. Hunter will thrive in a home with other cats.



SPCA Windhoek
145 Robert Mugabe Avenue,
Windhoek
Tel: 061-238 654
Emergency Cell: 081-124 4520
(After Hours Only)
Email: info@spcawindhoek.org.na



NOTIFICATION AND CALL FOR PUBLIC PARTICIPATION ENVIRONMENTAL IMPACT ASSESSMENT (EIA) PROCESS FOR THE PROPOSED DEVELOPMENT OF 22 TELECOMMUNICATION BASE-TRANSCIVER STATION (BTS) TOWERS ON SELECTED SITES COUNTRYWIDE, NAMIBIA



D & P Engineers and Environmental Consultants hereby gives notice to all potentially Interested and Affected Parties (I&APs) that an application will be made to the Environmental Commissioner in terms of the Environmental Management Act (No. 7 of 2007) and the Environmental Impact Assessment Regulations (No. 30 of 1 February 2012), for the proposed development of twenty two (22) base transceiver station (BTS) towers.

Powercom (PTY) LTD herein referred to as the proponent has identified different areas that needs improved communication alternatives in Namibia due to growth in population and economic activities. To achieve the objective of improved telecommunication connectivity, Powercom has been appointed by Telecom Namibia its sister company to establish telecommunication towers across the identified different locations. In this respect, Powercom has identified sites to construct and operate 22 telecommunication base transceiver station towers across the country.

Powercom (the proponent) has appointed D&P Engineers and Environmental Consultants to conduct the EIA process for these proposed BTS tower developments. The EIA is being conducted to satisfy the Namibian environmental legislative requirements. The general public as well as any Interested and Affected Parties (I&APs) are hereby invited to register their concerns and notify the consultant of any potential environmental and social impacts that may be triggered by the project.

The proposed projects for which the Environmental Clearance Certificates will be applied for are as follows:

<p>1. Project Title: Environmental Impact Assessment (EIA) Study for the Proposed Construction and Operation of a Telecommunication Base Transceiver Station (BTS) Tower at Sebem Settlement in, Karas Region.</p> <p>Location: Sebem Settlement, Karas Region - Namibia</p> <p>Coordinates: 26°49'02.8"S, 17°48'11.5"E</p>	<p>2. Project Title: Environmental Impact Assessment (EIA) Study for the Proposed Construction and Operation of a Telecommunication Base Transceiver Station (BTS) Tower at Lihongo Village in, Oshana Region.</p> <p>Location: Lihongo Village, Oshana Region - Namibia</p> <p>Coordinates: 18°02'21.8"S 18°30'24.7"E</p>	<p>Project Title: Environmental Impact Assessment (EIA) Study for the Proposed Construction and Operation of a Telecommunication Base Transceiver Station (BTS) Tower at Oshandja Village in Oshana Region.</p> <p>Location: Oshandja Village in Oshana Region - Namibia</p> <p>Coordinates: 17°49'28.0"S 15°38'17.1"E</p>	<p>Project Title: Environmental Impact Assessment (EIA) Study for the Proposed Construction and Operation of a Telecommunication Base Transceiver Station (BTS) Tower at Oshana Village in, Oshana Region.</p> <p>Location: Oshana Village in, Oshana Region - Namibia</p> <p>Coordinates: 17°52'15.3"S 15°37'42.2"E</p>
<p>Project Title: Environmental Impact Assessment (EIA) Study for the Proposed Construction and Operation of a Telecommunication Base Transceiver Station (BTS) Tower at Oshaneene Border Post, Oshana Region.</p> <p>Location: Oshaneene Border Post, Oshana Region - Namibia</p> <p>Coordinates: 17°25'05.0"S, 14°34'07.8"E</p>	<p>Project Title: Environmental Impact Assessment (EIA) Study for the Proposed Construction and Operation of a Telecommunication Base Transceiver Station (BTS) Tower at Epanga Village, Oshana Region.</p> <p>Location: Epanga Village, Oshana Region - Namibia</p> <p>Coordinates: 17°24'42.3"S, 18°20'14.7"E</p>	<p>Project Title: Environmental Impact Assessment (EIA) Study for the Proposed Construction and Operation of a Telecommunication Base Transceiver Station (BTS) Tower at Mujiji Village in, Karungo West Region - Namibia</p> <p>Location: Mujiji Village in, Karungo West Region - Namibia</p> <p>Coordinates: 17°52'48.8"S 18°37'52.4"E</p>	<p>Project Title: Environmental Impact Assessment (EIA) Study for the Proposed Construction and Operation of a Telecommunication Base Transceiver Station (BTS) Tower at Kangongo Village in, Karungo East Region.</p> <p>Location: Kangongo Village in, Karungo East Region - Namibia</p> <p>Coordinates: 17°57'01.7"S 22°08'52.5"E</p>
<p>Project Title: Environmental Impact Assessment (EIA) Study for the Proposed Construction and Operation of a Telecommunication Base Transceiver Station (BTS) Tower at Gurus, Oshana Region - Namibia</p> <p>Location: Gurus, Oshana Region - Namibia</p> <p>Coordinates: 18°14'52.4"S 17°20'55.3"E</p>	<p>Project Title: Environmental Impact Assessment (EIA) Study for the Proposed Construction and Operation of a Telecommunication Base Transceiver Station (BTS) Tower at Kunene Village in, Zambezi Region.</p> <p>Location: Kunene Village, Zambezi Region - Namibia</p> <p>Coordinates: 17°47'28.3"S 24°36'56.5"E</p>	<p>Project Title: Environmental Impact Assessment (EIA) Study for the Proposed Construction and Operation of a Telecommunication Base Transceiver Station (BTS) Tower at Dolra Braaiwer in, Karas Region.</p> <p>Location: Dolra Braaiwer in, Karas Region - Namibia</p> <p>Coordinates: 22°25'02.3"S 17°08'37.6"E</p>	<p>Project Title: Environmental Impact Assessment (EIA) Study for the Proposed Construction and Operation of a Telecommunication Base Transceiver Station (BTS) Tower at Howebes 31 in, Karas Region.</p> <p>Location: Howebes Settlement, Karas Region - Namibia</p> <p>Coordinates: 18°49'02.3"S, 17°48'11.5"E</p>
<p>Project Title: Environmental Impact Assessment (EIA) Study for the Proposed Construction and Operation of a Telecommunication Base Transceiver Station (BTS) Tower at Uuyuka Village, Oshana Region.</p> <p>Location: Uuyuka Village, Oshana Region - Namibia</p> <p>Coordinates: 17°57'24.7"S 18°20'33.1"E</p>	<p>Project Title: Environmental Impact Assessment (EIA) Study for the Proposed Construction and Operation of a Telecommunication Base Transceiver Station (BTS) Tower at Uuovulpa Village in, Oshana Region.</p> <p>Location: Uuovulpa Village in, Oshana Region - Namibia</p> <p>Coordinates: 18°58'05.7"S 17°27'55.3"E</p>	<p>Project Title: Environmental Impact Assessment (EIA) Study for the Proposed Construction and Operation of a Telecommunication Base Transceiver Station (BTS) Tower at Namakwale Amunungwale Village in, Oshana Region.</p> <p>Location: Namakwale Amunungwale Village in, Oshana Region - Namibia</p> <p>Coordinates: 17°29'42.0"S 15°08'51.0"E</p>	<p>Project Title: Environmental Impact Assessment (EIA) Study for the Proposed Construction and Operation of a Telecommunication Base Transceiver Station (BTS) Tower at Oshandja Village in, Oshana Region.</p> <p>Location: Oshandja Village in, Oshana Region - Namibia</p> <p>Coordinates: 17°54'05.8"S 15°38'15.8"E</p>
<p>Project Title: Environmental Impact Assessment (EIA) Study for the Proposed Construction and Operation of a Telecommunication Base Transceiver Station (BTS) Tower at Tandora Settlement in, Karungo West Region - Namibia</p> <p>Location: Tandora Settlement in, Karungo West Region - Namibia</p> <p>Coordinates: 17°46'17.6"S 18°17'23.5"E</p>	<p>Project Title: Environmental Impact Assessment (EIA) Study for the Proposed Construction and Operation of a Telecommunication Base Transceiver Station (BTS) Tower at Ndonga Lintea Settlement in Karungo East Region.</p> <p>Location: Ndonga Lintea Settlement in Karungo East Region - Namibia</p> <p>Coordinates: 17°57'06.8"S 20°28'12.0"E</p>	<p>Project Title: Environmental Impact Assessment (EIA) Study for the Proposed Construction and Operation of a Telecommunication Base Transceiver Station (BTS) Tower at Dvosh Settlement in, Karungo East Region - Namibia</p> <p>Location: Dvosh Settlement in, Karungo East Region - Namibia</p> <p>Coordinates: 18°09'14.8"S 21°28'15.9"E</p>	<p>Project Title: Environmental Impact Assessment (EIA) Study for the Proposed Construction and Operation of a Telecommunication Base Transceiver Station (BTS) Tower at Nalibobekus Village in, Zambezi Region.</p> <p>Location: Nalibobekus Village in, Zambezi Region - Namibia</p> <p>Coordinates: 17°49'23.7"S 24°50'11.0"E</p>
<p>Project Title: Environmental Impact Assessment (EIA) Study for the Proposed Construction and Operation of a Telecommunication Base Transceiver Station (BTS) Tower at Mutikilla Village in Zambezi Region.</p> <p>Location: Mutikilla Village in Zambezi Region - Namibia</p> <p>Coordinates: 17°55'40.4"S 24°37'42.0"E</p>	<p>Project Title: Environmental Impact Assessment (EIA) Study for the Proposed Construction and Operation of a Telecommunication Base Transceiver Station (BTS) Tower at Walvis Bay Extension 17 in, Erongo Region - Namibia</p> <p>Location: Walvis Bay Extension 17 in, Erongo Region - Namibia</p> <p>Coordinates: To be Confirmed</p>		

Contact Details: D&P Engineers and Environmental Consultants
Attention: Mr. T Kedingeni
PO Box 8402, Windhoek, Namibia
Email: t.kedingeni@dap.com.na
Tel: +264 61 302672

Interested & Affected Parties (I&AP) Registration and submission of comments: To comment or receive further information on the project, please register with the consultant (contact details below) as an I&AP before end of business on **25 September 2022**. A Background Information Document (BID) has been compiled for the project and is available upon request to the consultant, contact below.

All registered I&APs will be informed throughout the assessment process and will be provided with further opportunities for review and submission of comments. Comments can also be lodged via the online form given.

<https://forms.gle/9F6C6mDpU6u60>

INFORMATION AND COMMUNICATION TECHNOLOGY FOCUS - 30 SEPTEMBER 2022

TECHNOLOGY ENHANCEMENTS
ARTIFICIAL INTELLIGENCE
BOARDROOM SOLUTIONS
PAYMENT SOLUTIONS
DATA MANAGEMENT
COMMUNICATION
GAMING
MORE...

**BOOK YOUR
ADVERTISING
AND EDITORIAL
SPACE TODAY!**



CONTACT PETER ON 085 750 6616 OR advertise@observer.com.na









SITE INCEPTION REGISTER:

**ENVIRONMENTAL AND SOCIAL MANAGEMENT PLAN: THE PROPOSED TELECOMMUNICATION
BASE TRANSCIVER STATION (BTS) TOWER AT IKUMWE VILLAGE, ZAMBEZI REGION-NAMIBIA**

VENUE: IKUMWE VILLAGE

TIME: 13:30

DATE: 19/Sept/2022

NAME	Organisation/ Location	PHONE NUMBER	SIGNATURE
Simuna Linus	Ikumwe C.S	0812092995	
Brenda Sisamu	Ikumwe Area	0813337841	
Lutombi gwen	Ikumwe Area	0813402267	
Sinasiku Masiye	Ikumwe School	0813030511	
Musottar Pierre	Ikumwe Area	0817593101	
Nyumbae Theresa	Ikumwe Area	0817416000	
Musothu G.M.	Ikumwe	0812181728	
NTEAMO lusele M	Ikumwe	0816040736	
Muhinda Anastacia	Ikumwe	0812190341	

REGISTRATION AND COMMENTS FORM

ENVIRONMENTAL AND SOCIAL MANAGEMENT PLAN: THE PROPOSED
TELECOMMUNICATION BASE TRANSCIEVER STATION (BTS) TOWER AT IKUMWE
VILLAGE, ZAMBEZI REGION-NAMIBIA

KINDLY COMPLETE THIS FORM IN DETAIL AND RETURN TO:

D&P Engineers and environmental consultants
Environmental Consultant: Tendai E. Kasinganeti
Phone: +264813634904
Fax: +264 61 255 207
Email: tkasinganeti@dpe.com.na

PERSONAL DETAILS

Name & Surname: DENNIS MUKENA
Postal Address: P.O. BOX 2031, NGWAZE Email: dennis.mukena@yahoo.com
Town: IKUMWE

What is your main area of interest regarding the proposed developments?

- # I will strengthen the networking system within the area
- # Solve the issue of communication in terms of telecomm.unication
- # Cut the issue of data roaming

Do you have any points of concern or support regarding the proposed projects?
If "yes", please briefly list these in point format:

YES / NO

N/A

Do you wish this project to proceed?

YES / NO

STAMP/SIGNATURE

REGISTRATION AND COMMENTS FORM

ENVIRONMENTAL AND SOCIAL MANAGEMENT PLAN: THE PROPOSED
TELECOMMUNICATION BASE TRANSCIEVER STATION (BTS) TOWER AT IKUMWE
VILLAGE, ZAMBEZI REGION-NAMIBIA

KINDLY COMPLETE THIS FORM IN DETAIL AND RETURN TO:

D&P Engineers and environmental consultants
Environmental Consultant: Tendai E. Kasinganeti
Phone: +264813634904
Fax: +264 61 255 207
Email: tkasinganeti@dpe.com.na

PERSONAL DETAILS

Name & Surname Muhinda Anastacia Ntuala
Postal Address Box 1000 NGWEZE Email
Town Katima Mulilo

What is your main area of interest regarding the proposed developments?

for network connection
implementation, creation
Business linkages

Do you have any points of concern or support regarding the proposed projects?
If "yes", please briefly list these in point format:

Yes: for job creation YES / NO

Do you wish this project to proceed?

YES / NO

STAMP/SIGNATURE

AK

REGISTRATION AND COMMENTS FORM

ENVIRONMENTAL AND SOCIAL MANAGEMENT PLAN: THE PROPOSED
TELECOMMUNICATION BASE TRANSCIEVER STATION (BTS) TOWER AT IKUMWE
VILLAGE, ZAMBEZI REGION-NAMIBIA

KINDLY COMPLETE THIS FORM IN DETAIL AND RETURN TO:

D&P Engineers and environmental consultants
Environmental Consultant: Tendai E. Kasinganeti
Phone: +264813634904
Fax: +264 61 255 207
Email: tkasinganeti@dpe.com.na

PERSONAL DETAILS

Name & Surname... HARRIS MABITA
Postal Address... P.O. Box 1371, NGWERE Email Mabitaharris@gmail.com
Town... KATIMA MULILO 0818960654

What is your main area of interest regarding the proposed developments?

This is a very good project to the area because it will improve the communication in this area as there is a very bad network. We normally receive SMS (texts) from communication providers from Botswana due to poor network of this area.

Do you have any points of concern or support regarding the proposed projects?
If "yes", please briefly list these in point format:

I do support as this is good for opportunity for business. Communications as there's too much inter-paragon Botswana and we get charged for international charges while we are in our area.

.....

.....

YES / NO

Do you wish this project to proceed?

YES / NO

STAMP/SIGNATURE



REGISTRATION AND COMMENTS FORM

ENVIRONMENTAL AND SOCIAL MANAGEMENT PLAN: THE PROPOSED
TELECOMMUNICATION BASE TRANSCIVER STATION (BTS) TOWER AT IKUMWE
VILLAGE, ZAMBEZI REGION-NAMIBIA

KINDLY COMPLETE THIS FORM IN DETAIL AND RETURN TO:

D&P Engineers and environmental consultants
Environmental Consultant: Tendai E. Kasinganeti
Phone: +264813634904
Fax: +264 61 255 207
Email: tkasinganeti@dpe.com.na

PERSONAL DETAILS

Name & Surname Pierre MUYOHN
Postal Address Box 1214 Email
Town Katima Mulilo

What is your main area of interest regarding the proposed developments?

Ikumwe
.....
.....
.....

Do you have any points of concern or support regarding the proposed projects?
If "yes", please briefly list these in point format:

yes YES / NO
for better studies
for better communication
for better on line business, banking on line

Do you wish this project to proceed?

YES / NO

MUYOHN
STAMP/SIGNATURE

REGISTRATION AND COMMENTS FORM

ENVIRONMENTAL AND SOCIAL MANAGEMENT PLAN: THE PROPOSED
TELECOMMUNICATION BASE TRANSCIEVER STATION (BTS) TOWER AT IKUMWE
VILLAGE, ZAMBEZI REGION-NAMIBIA

KINDLY COMPLETE THIS FORM IN DETAIL AND RETURN TO:

D&P Engineers and environmental consultants
Environmental Consultant: Tendai E. Kasinganeti
Phone: +264813634904
Fax: +264 61 255 207
Email: tkasinganeti@dpe.com.na

PERSONAL DETAILS

Name & Surname *Lutombi gwen*
Postal Address *N/A* Email *N/A*
Town *Katima rural*

What is your main area of interest regarding the proposed developments?

*My interest is at least it will change the community
for better internet use and it will help people
to be used in good communication.*

Do you have any points of concern or support regarding the proposed projects?
If "yes", please briefly list these in point format:

*Yes it will support the business
of people who depend on business
it will support youths for depend on
internet for IT classes
it will support learners for further
education.*

YES / NO

Do you wish this project to proceed?

YES / NO

STAMP/SIGNATURE

E. Gwen

REGISTRATION AND COMMENTS FORM

ENVIRONMENTAL AND SOCIAL MANAGEMENT PLAN: THE PROPOSED
TELECOMMUNICATION BASE TRANSCIEVER STATION (BTS) TOWER AT IKUMWE
VILLAGE, ZAMBEZI REGION-NAMIBIA

KINDLY COMPLETE THIS FORM IN DETAIL AND RETURN TO:

D&P Engineers and environmental consultants
Environmental Consultant: Tendai E. Kasinganeti
Phone: +264813634904
Fax: +264 61 255 207
Email: tkasinganeti@dpe.com.na

PERSONAL DETAILS

Name & Surname MUJOHN GRACE MWANGALA
Postal Address IKUMWE AREA Email mujohn.gm@gmail.com
Town KATIMA MULILO 8125728

What is your main area of interest regarding the proposed developments?
IKUMWE

Do you have any points of concern or support regarding the proposed projects?
If "yes", please briefly list these in point format:

Better or improve communication YES / NO
To improve net work
Job Creation
Increase telecommunication connectivity
Expand connectivity beyond connectivity and provide
ITC at our area

Do you wish this project to proceed?

YES / NO

STAMP/SIGNATURE

CG

REGISTRATION AND COMMENTS FORM

ENVIRONMENTAL AND SOCIAL MANAGEMENT PLAN: THE PROPOSED
TELECOMMUNICATION BASE TRANSCIEVER STATION (BTS) TOWER AT IKUMWE
VILLAGE, ZAMBEZI REGION-NAMIBIA

KINDLY COMPLETE THIS FORM IN DETAIL AND RETURN TO:

D&P Engineers and environmental consultants
Environmental Consultant: Tendai E. Kasinganeti
Phone: +264813634904
Fax: +264 61 255 207
Email: tkasinganeti@dpe.com.na

PERSONAL DETAILS

Name & Surname..... *SINONLA LINDS*
Postal Address..... *PO BOX 2480* Email *linosinonla@gmail.com*
Town..... *KATIMA Nuliko*

What is your main area of interest regarding the proposed developments?

*The school staff need this tower due to
poor network here.
* Network roaming from
**

Do you have any points of concern or support regarding the proposed projects?
If "yes", please briefly list these in point format:

YES / NO

** poor connectivity,
* will help us do activities on line
* Access to quality information.*

Do you wish this project to proceed?

YES / NO

STAMP/SIGNATURE

REGISTRATION AND COMMENTS FORM

ENVIRONMENTAL AND SOCIAL MANAGEMENT PLAN: THE PROPOSED
TELECOMMUNICATION BASE TRANSCIEVER STATION (BTS) TOWER AT IKUMWE
VILLAGE, ZAMBEZI REGION-NAMIBIA

KINDLY COMPLETE THIS FORM IN DETAIL AND RETURN TO:

D&P Engineers and environmental consultants
Environmental Consultant: Tendai E. Kasinganeti
Phone: +264813634904
Fax: +264 61 255 207
Email: tkasinganeti@dpe.com.na

PERSONAL DETAILS

Name & Surname Mulela Matongo
Postal Address P.O. Box 907, Ngwez Email mmulela2@gmail.com
Town Katinga Mulilo

What is your main area of interest regarding the proposed developments?

- Improved network connections.
- Better education programmes.
- Easy communication between people or residents.
- Easy use of internet network.

Do you have any points of concern or support regarding the proposed projects?
If "yes", please briefly list these in point format:

- Better business opportunities as the business person can easily communicate.
- We usually use Botswana network which charges us so heavily.
- Network is very weak and slow so we want better network usage.

YES / NO

Do you wish this project to proceed?

YES / NO

STAMP/SIGNATURE



REGISTRATION AND COMMENTS FORM

ENVIRONMENTAL AND SOCIAL MANAGEMENT PLAN: THE PROPOSED
TELECOMMUNICATION BASE TRANSCEIVER STATION (BTS) TOWER AT IKUMWE
VILLAGE, ZAMBEZI REGION-NAMIBIA

KINDLY COMPLETE THIS FORM IN DETAIL AND RETURN TO:

D&P Engineers and environmental consultants
Environmental Consultant: Tendai E. Kasinganeti
Phone: +264813634904
Fax: +264 61 255 207
Email: tkasinganeti@dpe.com.na

PERSONAL DETAILS

Name & Surname: Maxis SITALI MUTONGA
Postal Address: Email: MutongaMS@gmail.com
Town: Ikumwe

What is your main area of interest regarding the proposed developments?

- for better ^{network} connectivity and improve communication
- employment creation

Do you have any points of concern or support regarding the proposed projects?
If "yes", please briefly list these in point format:

- YES / NO
- because of Botswana network that is always roaming and it charges us more money. If this network will be brought here I think it will change for better network.
 - It will improve the educational level of our learners because will have network available

Do you wish this project to proceed?

YES / NO

STAMP/SIGNATURE

MutongaMS

REGISTRATION AND COMMENTS FORM

ENVIRONMENTAL AND SOCIAL MANAGEMENT PLAN: THE PROPOSED
TELECOMMUNICATION BASE TRANSCIVER STATION (BTS) TOWER AT IKUMWE
VILLAGE, ZAMBEZI REGION-NAMIBIA

KINDLY COMPLETE THIS FORM IN DETAIL AND RETURN TO:

D&P Engineers and environmental consultants
Environmental Consultant: Tendai E. Kasinganeti
Phone: +264813634904
Fax: +264 61 255 207
Email: tkasinganeti@dpe.com.na

PERSONAL DETAILS

Name & Surname ELIZABETH SILSHERO
Postal Address P.O. Box 1834 Email
Town KATIMA MULLO

What is your main area of interest regarding the proposed developments?

I want the tower to be installed in
our area in order to avoid barriers
in communication

Do you have any points of concern or support regarding the proposed projects?
If "yes", please briefly list these in point format:

- The tower is urgently needed YES / ~~NO~~
- The towers available are very
far from us

- If the tower is installed it will
make our work easier in many
areas

Do you wish this project to proceed?

YES / ~~NO~~

STAMP/SIGNATURE

Esbo

REGISTRATION AND COMMENTS FORM

ENVIRONMENTAL AND SOCIAL MANAGEMENT PLAN: THE PROPOSED
TELECOMMUNICATION BASE TRANSCIEVER STATION (BTS) TOWER AT IKUMWE
VILLAGE, ZAMBEZI REGION-NAMIBIA

KINDLY COMPLETE THIS FORM IN DETAIL AND RETURN TO:

D&P Engineers and environmental consultants
Environmental Consultant: Tendai E. Kasinganeti
Phone: +264813634904
Fax: +264 61 255 207
Email: tkasinganeti@dpe.com.na

PERSONAL DETAILS

Name & Surname MARY BEAUTY SIMASIKU
Postal Address P.O. BOX 659, NGWEZE Email marysimasiku4@gmail.com
Town IKUMWE

What is your main area of interest regarding the proposed developments?

- I am interested in the tower because it is going to improve network connectivity.
- Botswana network is affecting us. Taking our money.
- I am interested in this tower because will be able to use wifi properly.

Do you have any points of concern or support regarding the proposed projects?
If "yes", please briefly list these in point format:

- Improve network ~~connectivity~~ connectivity.
- Create employment.
- More business will come.
- The use of wifi at the school will improve.
- Improve the communications with different people, e.g. family members.

YES / NO

Do you wish this project to proceed?

YES / NO

STAMP/SIGNATURE

Mary Beauty

REGISTRATION AND COMMENTS FORM

ENVIRONMENTAL AND SOCIAL MANAGEMENT PLAN: THE PROPOSED
TELECOMMUNICATION BASE TRANSCIEVER STATION (BTS) TOWER AT IKUMWE
VILLAGE, ZAMBEZI REGION-NAMIBIA

KINDLY COMPLETE THIS FORM IN DETAIL AND RETURN TO:

D&P Engineers and environmental consultants
Environmental Consultant: Tendai E. Kasinganeti
Phone: +264813634904
Fax: +264 61 255 207
Email: tkasinganeti@dpe.com.na

PERSONAL DETAILS

Name & Surname: Brenda Sisamu
Postal Address: P.O. Box 56, Katima Mulilo
Town: Katima Mulilo, Namibia
Email: brendasamu@gmail.com

What is your main area of interest regarding the proposed developments?

* My main interest is it will reduce the poor coverage of network whereby communication will improve.

* Lastly but not least it will also improve employment whereby on line application will be done on our house holds.

Do you have any points of concern or support regarding the proposed projects?
If "yes", please briefly list these in point format:

Yes

YES / NO

* My concern is we need the tower because we are total suffering regarding study time. Research when we do on line studies we have a big challenge totally.

Do you wish this project to proceed?

YES / NO

STAMP/SIGNATURE

Brenda Sisamu

REGISTRATION AND COMMENTS FORM

ENVIRONMENTAL AND SOCIAL MANAGEMENT PLAN: THE PROPOSED
TELECOMMUNICATION BASE TRANSCIEVER STATION (BTS) TOWER AT IKUMWE
VILLAGE, ZAMBEZI REGION-NAMIBIA

KINDLY COMPLETE THIS FORM IN DETAIL AND RETURN TO:

D&P Engineers and environmental consultants
Environmental Consultant: Tendai E. Kasinganeti
Phone: +264813634904
Fax: +264 61 255 207
Email: tkasinganeti@dpe.com.na

PERSONAL DETAILS

Name & Surname MARJORIE NYELAMO LISELI
Postal Address P.O. Box 666 Email marjorielam@gmail.com
Town NGWEZE, K/MULITO

What is your main area of interest regarding the proposed developments?

Better communication, employment
creation to the community

Do you have any points of concern or support regarding the proposed projects?
If "yes", please briefly list these in point format:

YES I support the idea of bringing the tower in the area for
us to get better connectivity, fast
network, better education for
learners

YES / NO

Do you wish this project to proceed?

YES / NO

M. Liela
STAMP/SIGNATURE

REGISTRATION AND COMMENTS FORM

ENVIRONMENTAL AND SOCIAL MANAGEMENT PLAN: THE PROPOSED
TELECOMMUNICATION BASE TRANSCEIVER STATION (BTS) TOWER AT IKUMWE
VILLAGE, ZAMBEZI REGION-NAMIBIA

KINDLY COMPLETE THIS FORM IN DETAIL AND RETURN TO:

D&P Engineers and environmental consultants
Environmental Consultant: Tendai E. Kasinganeti
Phone: +264813634904
Fax: +264 61 255 207
Email: tkasinganeti@dpe.com.na

PERSONAL DETAILS

Name & Surname Theress Nyambe Namatikwa
Postal Address Ikumwe area Email
Town.....

What is your main area of interest regarding the proposed developments?

It will bring developments like
job creation to the youths and
better network communication.

Do you have any points of concern or support regarding the proposed projects?
If "yes", please briefly list these in point format:

We support the tower because
our money is wasted to
Mascom in Botswana.

YES / NO

Do you wish this project to proceed?

YES / NO

STAMP/SIGNATURE

Theress Nyambe

REGISTRATION AND COMMENTS FORM

ENVIRONMENTAL AND SOCIAL MANAGEMENT PLAN: THE PROPOSED
TELECOMMUNICATION BASE TRANSCIEVER STATION (BTS) TOWER AT IKUMWE
VILLAGE, ZAMBEZI REGION-NAMIBIA

KINDLY COMPLETE THIS FORM IN DETAIL AND RETURN TO:

D&P Engineers and environmental consultants
Environmental Consultant: Tendai E. Kasinganeti
Phone: +264813634904
Fax: +264 61 255 207
Email: tkasinganeti@dpe.com.na

PERSONAL DETAILS

Name & Surname Mr. Simaiku Masiye
Postal Address P.O. Box 499, KATIMA MULITO Email omasuwei@yahoo.com
Town KATIMA MULITO, IKUMWE AREA

What is your main area of interest regarding the proposed developments?

- Better connectivity
- Network
- To improve our network and communication
- Fast internet connectivity
- to bring in investors
- Job Creation

Do you have any points of concern or support regarding the proposed projects?
If "yes", please briefly list these in point format:

- Bring network at our disposal
- Improve network strength
- Job Creation
- Bring in investors
- at anytime Mafcom is overpowering NTC and we lose our data and airtime
- Better education
- Fast communication

YES / NO

Do you wish this project to proceed?

YES / NO

STAMP/SIGNATURE



REGISTRATION AND COMMENTS FORM

ENVIRONMENTAL AND SOCIAL MANAGEMENT PLAN: THE PROPOSED
TELECOMMUNICATION BASE TRANSCEIVER STATION (BTS) TOWER AT IKUMWE
VILLAGE, ZAMBEZI REGION-NAMIBIA

KINDLY COMPLETE THIS FORM IN DETAIL AND RETURN TO:

D&P Engineers and environmental consultants
Environmental Consultant: Tendai E. Kasinganeti
Phone: +264813634904
Fax: +264 61 255 207
Email: tkasinganeti@dpe.com.na

PERSONAL DETAILS

Name & Surname... SIBALATANI ALBERT
Postal Address... Box 114 MUKILO Email... 081 92 99770
Town... L. KUMWE AREA

What is your main area of interest regarding the proposed developments?

To provide the area with a tower TELECOM.
Also, to develop the area for the people.
It should be done earlier.

Do you have any points of concern or support regarding the proposed projects?
If "yes", please briefly list these in point format:

Yes, people of the area needs
developments in the area.
It is also good for future generations.

YES / NO

Do you wish this project to proceed?

YES / NO

Asstn

STAMP/SIGNATURE

REGISTRATION AND COMMENTS FORM

ENVIRONMENTAL AND SOCIAL MANAGEMENT PLAN: THE PROPOSED
TELECOMMUNICATION BASE TRANSCIVER STATION (BTS) TOWER AT IKUMWE
VILLAGE, ZAMBEZI REGION-NAMIBIA

KINDLY COMPLETE THIS FORM IN DETAIL AND RETURN TO:

D&P Engineers and environmental consultants
Environmental Consultant: Tendai E. Kasinganeti
Phone: +264813634904
Fax: +264 61 255 207
Email: tkasinganeti@dpe.com.na

PERSONAL DETAILS

Name & Surname MUKENA AGEREY MUKENA
Postal Address Box 2031, NGWENE Email
Town Ka.ima Mulilo

What is your main area of interest regarding the proposed developments?

It is important for us to have network coverage
We don't want roaming network like Mascom

Do you have any points of concern or support regarding the proposed projects?
If "yes", please briefly list these in point format:

YES / NO

N/A

Do you wish this project to proceed?

YES / NO

STAMP/SIGNATURE
[Signature]

REGISTRATION AND COMMENTS FORM

ENVIRONMENTAL AND SOCIAL MANAGEMENT PLAN: THE PROPOSED
TELECOMMUNICATION BASE TRANSCIEVER STATION (BTS) TOWER AT IKUMWE
VILLAGE, ZAMBEZI REGION-NAMIBIA

KINDLY COMPLETE THIS FORM IN DETAIL AND RETURN TO:

D&P Engineers and environmental consultants
Environmental Consultant: Tendai E. Kasinganeti
Phone: +264813634904
Fax: +264 61 255 207
Email: tkasinganeti@dpe.com.na

PERSONAL DETAILS

Name & Surname: Mchinda Chisipini Sansindi
Postal Address: Ikumwe area Email:
Town: Ikumwe

What is your main area of interest regarding the proposed developments?

better access to the coverage of the network, and solve
the problem of network roaming or break down in
the area.

Do you have any points of concern or support regarding the proposed projects?
If "yes", please briefly list these in point format:

YES / NO

N/A

Do you wish this project to proceed?

YES / NO

STAMP/SIGNATURE

Mchinda

REGISTRATION AND COMMENTS FORM

ENVIRONMENTAL AND SOCIAL MANAGEMENT PLAN: THE PROPOSED
TELECOMMUNICATION BASE TRANSCIVER STATION (BTS) TOWER AT IKUMWE
VILLAGE, ZAMBEZI REGION-NAMIBIA

KINDLY COMPLETE THIS FORM IN DETAIL AND RETURN TO:

D&P Engineers and environmental consultants
Environmental Consultant: Tendai E. Kasinganeti
Phone: +264813634904
Fax: +264 61 255 207
Email: tkasinganeti@dpe.com.na

PERSONAL DETAILS

Name & Surname MUSDHAN LUCKYSHINE 0814642178
Postal Address Box 1214 NGWERE Email N/A
Town KATIMA MULILO / IKUMWE

What is your main area of interest regarding the proposed developments?

The community of Ikumwe area are interested of the tower for internet. Our network is very poor. We are connected by the Botswana network.

Do you have any points of concern or support regarding the proposed projects?
If "yes", please briefly list these in point format:

YES / NO

We don't have therefore we want our tower to be higher than because we are near Botswana where their towers are higher because their land is higher than Zambezi Region.

Do you wish this project to proceed?

YES / NO

STAMP/SIGNATURE

[Handwritten Signature]

REGISTRATION AND COMMENTS FORM

ENVIRONMENTAL AND SOCIAL MANAGEMENT PLAN: THE PROPOSED
TELECOMMUNICATION BASE TRANSCIVER STATION (BTS) TOWER AT IKUMWE
VILLAGE, ZAMBEZI REGION-NAMIBIA

KINDLY COMPLETE THIS FORM IN DETAIL AND RETURN TO:

D&P Engineers and environmental consultants
Environmental Consultant: Tendai E. Kasinganeti
Phone: +264813634904
Fax: +264 61 255 207
Email: tkasinganeti@dpe.com.na

PERSONAL DETAILS

Name & Surname: BERNARD MILINGA
Postal Address: BOX 2357 NGUNDE Email: chikaph73@yahoo.com
Town: KUMULO / IKUMWE AREA

What is your main area of interest regarding the proposed developments?

1. To stop roaming from foreign networks
2. To add our bills, get to be on the same level with the world.
3. To be connect with the world
- 4.

Do you have any points of ~~concern~~ or support regarding the proposed projects?
If "yes", please briefly list these in point format:

YES / NO
~~NO~~ To help the Roaming & to connect the people to the world.
To work or leave the people communicate with their families.
To have a high network tower (antennas) to consider the height of the trees at the area.

Do you wish this project to proceed?

YES / NO

STAMP/SIGNATURE





Appendix B:

Maps and Layouts

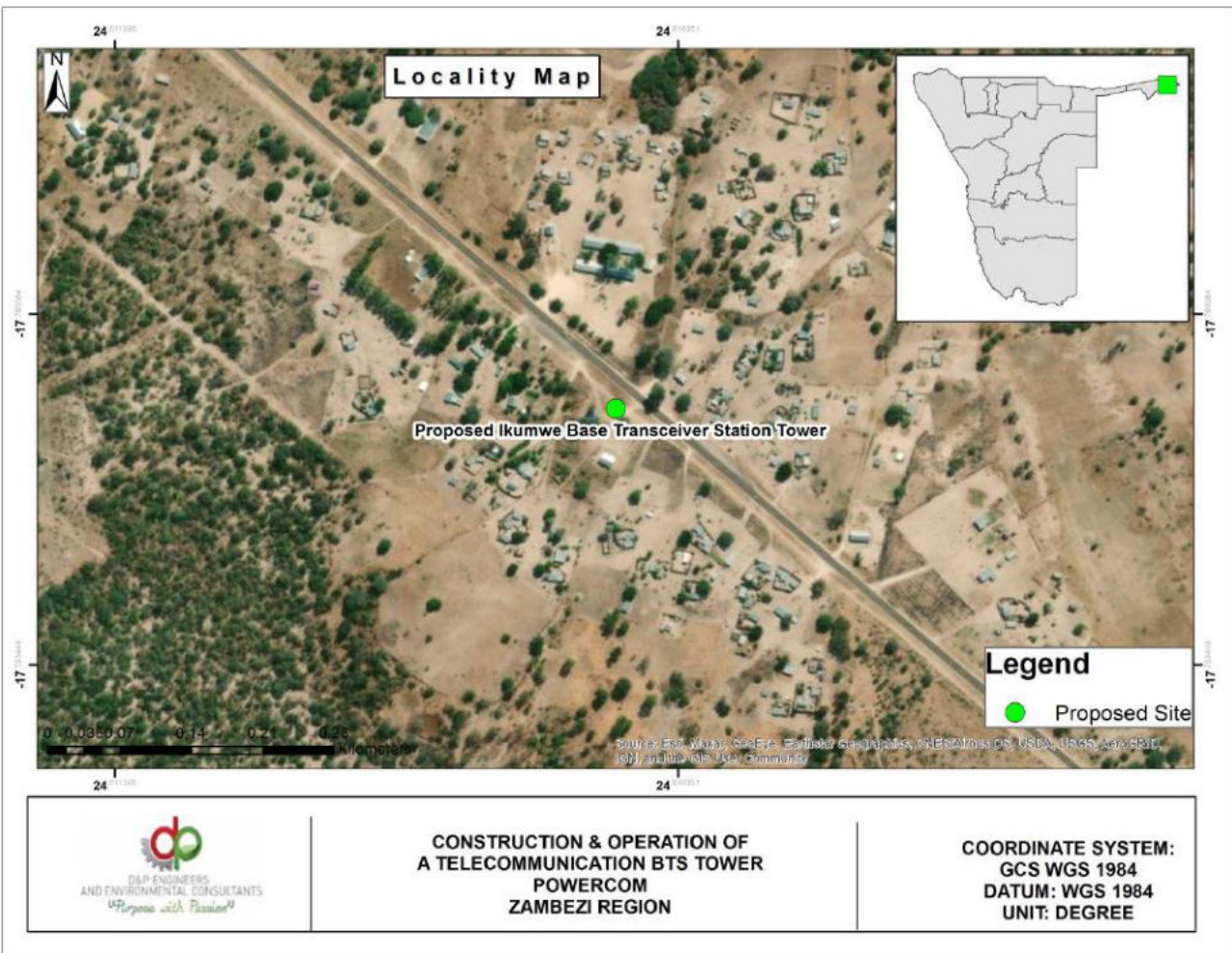
- 1. Locality Map**
- 2. Layout Plan**

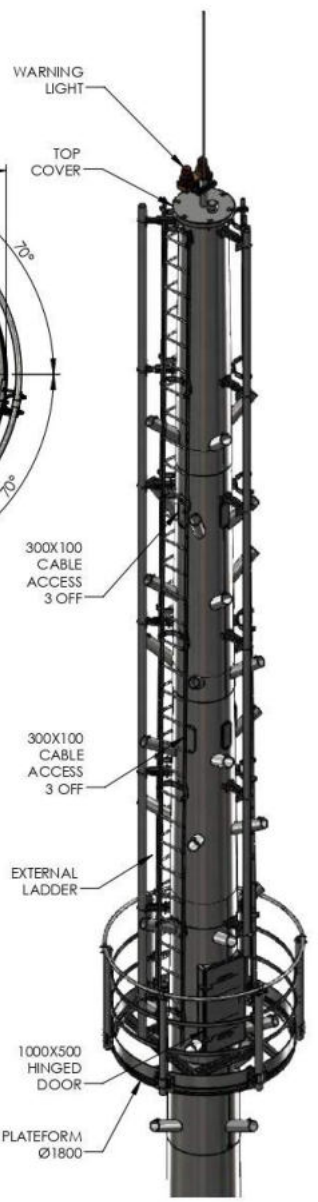
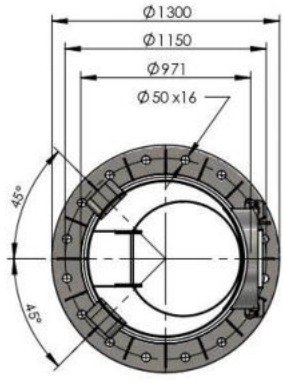
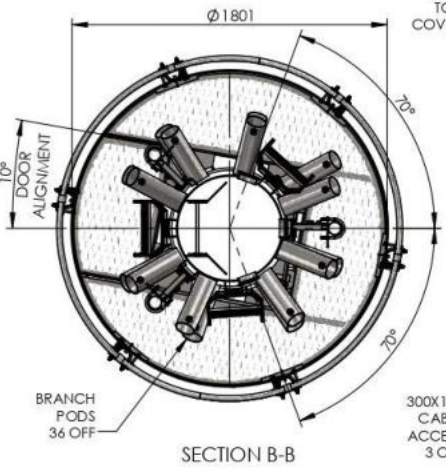
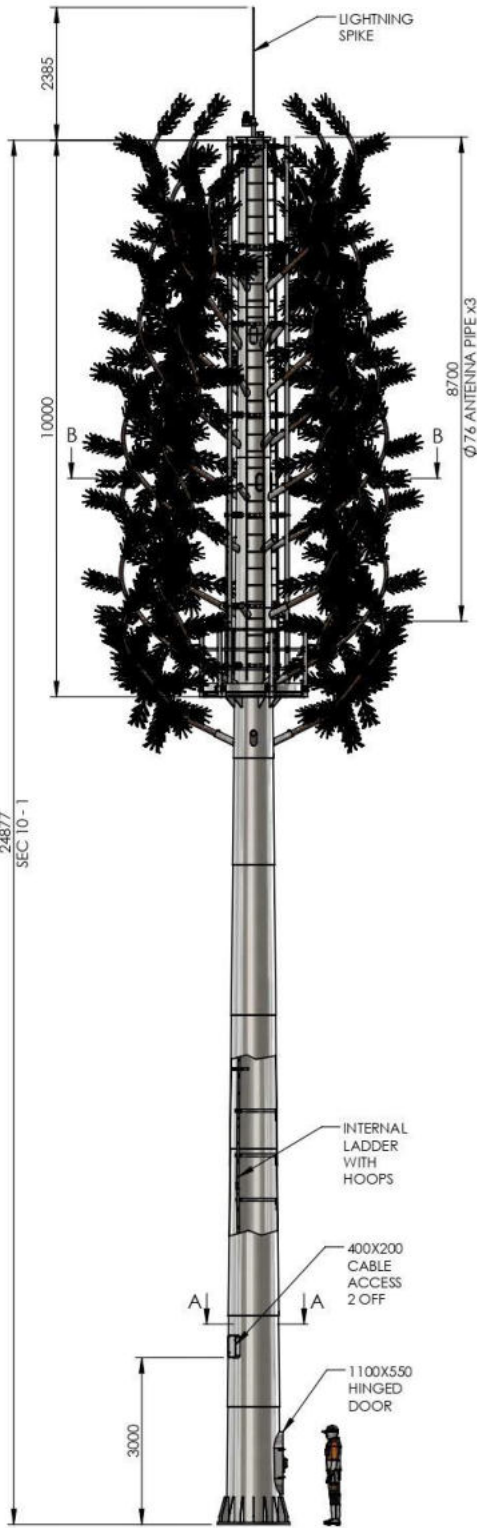



0		TLF	2020/09/14
REV	DESCRIPTION	DRAWN	DATE
DESIGN REFERENCE:			
 Sectional Poles SINCE 1960		UNLESS STATED OTHERWISE, DIMENSIONS IN mm DO NOT SCALE	
TITLE: 25m CT PINE WITH 10m PLATFORM & 3X 8m ANTENNA PIPES		DIMENSIONS: 0-1m ±0.5mm 1-3m ±1.0mm	
DRW NO: ILG25PI-10PL-TV10B-UNV-R0		ANGLES: ±2°	
CLIENT:		SHEET: 1 OF 1	

Appendix C:

Land Tenure, Approvals and Licenses

- 1. Proof of Land Ownership/
Authorisation for
development/ Consent for
Development**



MASUBIA TRADITIONAL AUTHORITY

BUKALO ROYAL HEADQUARTERS
TEL/FAX NO: (+264)66254715
P.O.BOX 6017
BUKALO
REPUBLIC OF NAMIBIA

The Manager
PowerCom (pty) Ltd
P.O.Box40799
Windhoek
05/01/2022

Re: Application for the Establishment for the Communication Tower at Ikumwe Area

This is to certify that PowerCom been granted permission by the Masubia Traditional Authority with consultation with Ikumwe Sub-khuta and the entire community to erect communication tower in that area under this Traditional Authority.

Your esteemed office is therefore requested to proceed with the establishment of the tower to serve the community in and around the area.

We count on your usual cooperation

Yours faithfully

Albius M. Kamwi
Hon Ngambela



pp. 
Albius M. Mwala
Senior Induna

Appendix D:

EIA Team Resumes

- 1. Mr. Tendai E. Kasinganeti**
- 2. Ms. Shiwayu Kristian NN**

Curriculum Vitae (CV) for Tendai. Kasinganeti

1. **Proposed Position:** Environmental Assessment Practitioner
2. **Name of Firm** D&P Engineers and Environmental consultants
3. **Name of Staff** Evidence Tendai Kasinganeti
4. **Date of Birth:** 27 November 1991 **Nationality:** Zimbabwean
5. Education:

Name of University or institution, location, dates attended (year from – year to)	Degree(s)/diploma(s) obtained
Midlands State University, Zimbabwe (11/12011 – 05/2015)	BSc Hons. Geography and Environmental Science Thesis „Spatial and temporal analysis of base transceiver stations development and associated environmental impacts (Zimbabwe)
National University of Science and Technology 2018-2020 (Ongoing)	Master of Geoinformation Science and Earth Observation (Natural Resources Management)

-
6. **Membership of Professional Associations:**
 - Environmental Assessment Professionals of Namibia (EAPAN)
 - International Association for Impact Assessment (IAIA)
-

7. **Other Training:**

Further education:

- Certificate on Going Green for Social Entrepreneurs (Young African Leaders Initiative Network, USA, 2016)
 - Fundamentals of Health and Safety in the Workplace (Allison International, Ireland, 2016)
 - Introduction to Ecosystem Service Valuation and Policy Design (RESMOB Namibia, 2018)
-

8. **Countries of Work Experience:**

- Namibia
- Zimbabwe
- Mozambique

9. **Languages:**

Language	Reading	Speaking	Writing
English	excellent	excellent	Excellent

10. **Employment Record:**

Employment record relevant to the assignment:		
Period	Employing organization and your title/position. Contact info for references	Summary of activities performed relevant to the Assignment

CURRICULUM VITAE Tendai E. Kasinganeti (*Environmental Expert (Backstopper)*)

April 2018 to date	<p>Environmental Practitioner and Consultant</p> <p>Mr. Timo David Director: Project Management D&P Engineers and Environmental Consultants E: tdavid@dpe.com.na</p>	<ul style="list-style-type: none"> ▪ GIS mapping and Environmental Sensitivity mapping. ▪ Providing professional consulting services to clients in Namibia with focus on EIAs, EMPs reporting and compliance advisory. ▪ Conducting Environmental Scoping Assessments and Environmental Management Plans ▪ Application for Environmental Clearance Certificates ▪ Environmental Control for projects during construction and operation. ▪ Environmental Quarterly and Biannual reporting ▪ Environmental monitoring and compliance auditing.
January 2016 to April 2018	<p>Environmental Planner</p> <p>Mr. Henry Krohne Director-Plan Africa Consulting E: pafrica@mweb.com.na</p>	<ul style="list-style-type: none"> ▪ Coordinating and managing Environmental Impact Assessment Studies: ▪ Environmental Reports writing. ▪ Conducting Bio-Physical studies. ▪ Stakeholder engagement and consultation ▪ Environmental Monitoring and Auditing ▪ Land use Mapping and GIS
July 2013 to December 2015	<p>-Student intern -Junior Environmental and Spatial Consultant</p> <p>Mr. Anesu Mudiwa Director: Nwas Environmental Consulting E: anesu@nwas.co.zw W: www.nwas.co.zw</p>	<ul style="list-style-type: none"> ▪ Occupational Health, Safety and Environmental Management ▪ Baseline surveys for EIA projects (Social, ecological, economic and political impact Assessment) ▪ Compiling Environmental and Social Impact Assessment Reports for different projects ▪ Public and Stakeholder consultation ▪ Environmental Compliance Auditing and Quarterly Reports ▪ Soil and water samples processing (Sample collecting, sending for lab tests and interpretation of results) ▪ Emissions testing

<p>11. Detailed Tasks Assigned</p> <ul style="list-style-type: none"> • Stakeholders Engagement • Legislative Frameworks Review • Environmental Compliance Manual and Guidelines Development • Team Leader Backstopper 	<p>12. Work Undertaken that Best Illustrates Capability to Handle the Tasks Assigned</p> <p><i>[Among the assignments in which the staff has been involved, indicate the following information for those assignments that best illustrate staff capability to handle the tasks listed under point 11.]</i></p> <p>Name of assignment or project: Environmental Management Plans development</p> <p>Year: 2017/18</p> <p>Location: Namibia (All Regions) -56 Fuel Retail facilities</p> <p>Client: Engen Namibia/ Nam-Geo Enviro Solutions</p> <p>Main project features:</p> <ul style="list-style-type: none"> • EHS Auditing • Environmental Management Plans Development • Application for Environmental Clearance Certificates for service stations (New application/ Renewals) • Develop EHS monitoring and compliance schedule • Conduct site risk assessment and recommend corrective action plan <hr/> <p>Name of assignment or project: Namibia Water Support Programme</p>
---	---

CURRICULUM VITAE **Tendai E. Kasinganeti** (*Environmental Expert (Backstopper)*)

	<p>Year: 2019</p> <p>Location: Namibia (All Regions)</p> <p>Client: Ministry of Agriculture Water and Forestry/ African Development Bank</p> <p>Main project features:</p> <ul style="list-style-type: none"> • Strategic Environmental and Social Assessment/ Strategic Environmental and Social Management Framework • Environmental Compliance Guidelines for implementing the Namibia Water Sector Support Programme <p>Positions held: Environmental and Social Assessment Expert_</p> <p>Activities performed:</p> <ul style="list-style-type: none"> • Stakeholders Consultation • Regional Workshops • Baseline Environmental Scoping Assessment • Institutional Capability and Needs Assessment for Environmental Compliance • Strategic Environmental and Social Assessment Development (SESA) • Strategic Environmental and Social Management Framework (ESMF) • ESMF Workshop and Compliance Training
	<p>Name of assignment or project: Etunda Feedlot</p> <p>Year: 2019</p> <p>Location: Etunda, Omusati Region-Namibia</p> <p>Client: Ministry of Agriculture Water and Forestry/ European Union</p> <p>Main project features:</p> <ul style="list-style-type: none"> • Environmental and Social Impact Assessment (ESIA)/ Environmental and Social Management Plan (ESMP) <p>Positions held: Environmental and Social Assessment Expert_</p> <p>Activities performed:</p> <ul style="list-style-type: none"> • Environmental Scoping Assessment • National, Regional and International Legal Frameworks Review • Public and Stakeholders Consultation • Groundwater Impact Assessment • Sensitivity Mapping • Environmental and Social Management Plan Development
	<p>Name of assignment or project: Le'Monte Village Development (Township Establishment and Incorporation)</p> <p>Year: 2018</p> <p>Location: Grootfontein, Otjozondjupa Region-Namibia</p> <p>Client: Singleton Commercial Pty Ltd</p>

CURRICULUM VITAE **Tendai E. Kasinganeti** (*Environmental Expert (Backstopper)*)

	<p>Main project features:</p> <ul style="list-style-type: none"> • Environmental and Social Impact Assessment (ESIA)/ Environmental and Social Management Plan (ESMP) <p>Positions held: Environmental and Social Assessment Expert_</p> <p>Activities performed:</p> <ul style="list-style-type: none"> • Environmental Scoping Assessment • National, Regional and International Legal Frameworks Review • Public and Stakeholders Consultation • Groundwater Impact Assessment • Sensitivity Mapping • Environmental and Social Management Plan Development
--	---

ADDITIONAL PROJECTS EXPERIENCES

Client, Year and Country	Project Name and Deliverable
GIZ and Ministry of Agriculture Water and Land Reform, 200-21-Namibia	Flexible Land Tenure System: Environmental and Social Management and Compliance Guideline Manual for the Flexible Land Tenure Implementation
Centre for Natural Resources Governance, 2020-21- Zimbabwe and Zambia	Coal mining and thermal power generation in Sengwa-Kariba areas Zimbabwe: Environmental and Social Impact Assessment-Focus on Environmental Rights and Gender impacts
European Union and Ministry of Agriculture, Water and Forestry, 2020-Namibia	Program to improve livestock efficiency and marketability in the Northern Communal Areas (NCAs) of Namibia: Various Environmental and Social Impact Assessments for specific projects
UNDP Namibia and Ministry of Mines and Energy, 2020-Namibia	Supporting livelihoods through small-scale mining of semi-precious stones, metals and minerals: Environmental, Health, Safety and Social Guidelines for Small Scale Miners in Namibia
AfDB and Ministry of Agriculture, Water and Forestry, 2019-Namibia	Namibia Water Sector Support Programme: Strategic Environmental and Social Assessment and Environmental and Social Management Framework
Keetmanshoop Medical Practice, 2018-Namibia	Keetmanshoop Private Hospital: Environmental and Social Impact Assessment.
Anpro Hides and Skins, 2018-Namibia	Anpro animal rendering plant and tannery: Environmental Impact Assessment

13. Certification:

I, the undersigned, certify that to the best of my knowledge and belief, this CV correctly describes myself, my qualifications, and my experience. I understand that any wilful misstatement described herein may lead to my disqualification or dismissal, if engaged.



[Signature of staff member or authorized representative of the staff] Date: 19-May-21
Day/Month/Year

Full name of authorized representative: Evidence Tendai Kasinganeti

KRISTIAN NDIIPANDA NDEKUPANDA SHIWAYU
ENVIRONMENTAL SCIENTIST
KRISTIAN SHIWAYU | LINKEDIN
LICENSE: LEARNER'S LICENSE

Name of Expert:	Shiwayu Kristian NN
Date of Birth:	03/01/1993
Country of Citizenship/Residence	Namibian Residence

1. Education:

ACADEMIC QUALIFICATIONS		
Name of Course	Institution	Year conferred
International General Certificate in Occupational Health and Safety Practice	NEBOSH	Ongoing
BSc Hons. Integrated Environmental Science	University of Namibia	2019
Master of Science in Integrated Environmental Science and Sustainable Development	The International University of Management	Ongoing

3. Employment Record:

Period	Employing organization and your title/position. Contact info for references	Country	Summary of activities performed relevant to the Assignment
Sept 2022 to date	-Intern: Environmental & Sustainability Consultant Mr. Timo David Director: Project Management D&P Engineers and Environmental Consultants E: tdavid@dpe.com.na	Namibia	<ul style="list-style-type: none">▪ Providing professional consulting services to clients in Namibia with focus on EIAs, EMPs reporting and compliance advisory.▪ Conducting Environmental Scoping Assessments and Environmental Management Plans▪ Application for Environmental Clearance Certificates

Jan 2021 to May 2022	<p>-Student Employment: Centre for Environmental Studies</p> <p>Mr Sioni Iikela</p> <p>Director: CES, IUM</p> <p>E: s.iikela@ium.edu.na</p> <p>W: 061 433 6412</p>	Namibia	<ul style="list-style-type: none"> ▪ Customer Service ▪ To assist the Centre director, and lecturing staff with all related functions and relevant logistical matters. ▪ Administrative functions ▪ Research
Oct 2020 to Jan 2021	<p>-Graduate Intern: Wildlife and National Parks Division</p> <p>Mr. J Amutenya</p> <p>Chief Warden (Central)</p> <p>Ministry of Environmental, forestry & Tourism (Windhoek)</p> <p>E: jeremia.amutenya@gmail.com</p> <p>W: +26481 0415182</p>	Namibia	<ul style="list-style-type: none"> ▪ Office administrative functions ▪ Law enforcement ▪ Human Wildlife Management ▪ CBNRM (Community Based Natural Resource Management) ▪ Research and Monitoring ▪ Ensure the sustainable utilization of wildlife within central areas of Namibia.
July 2020 to Sept 2020	<p>-Researcher</p> <p>Namibia Research Institution (Gobabeb)</p>	Namibia	<ul style="list-style-type: none"> ▪ Data processing and analyses ▪ Survey techniques ▪ Scientific presentations, while emphasizing teamwork ▪ Critical thinking ▪ Problem-solving skills
Aug 2019 to Sept 2019	<p>-Researcher/Enumerator</p> <p>Namibia agricultural Mechanisation and Seed Improvement Project (NAMSIP)</p>	Namibia	<ul style="list-style-type: none"> ▪ Interviewed farmers in Oshikoto Region ▪ Data collection ▪ Enter data collection in Microsoft Excel for data analyses.
Dec 2017 to Jan 2018	<p>-Field Attachment: Wildlife and National Parks Division</p> <p>Ministry of Environmental, forestry & Tourism (Windhoek)</p>	Namibia	<ul style="list-style-type: none"> ▪ Office administrative functions ▪ Law enforcement ▪ Human Wildlife Management ▪ CBNRM (Community Based Natural Resource Management) ▪ Research and Monitoring ▪ Ensure the sustainable utilization of wildlife within central areas of Namibia.
Dec 2016 to Jan 2017	<p>-Field Attachment: Environmental Officer</p> <p>Tschudi Copper Mine</p>	Namibia	<ul style="list-style-type: none"> ▪ Administration functions ▪ Conducted air quality monitoring ▪ Environmental inspection ▪ Data capturing ▪ Minute taking at the interested and affected parties.

4. **Membership of Professional Associations:**

- Recycle Namibia Forum

5. **Countries of Work Experience:** Namibia (SADC Region)

6. **Languages:**

	<u>Speaking</u>	<u>Reading</u>	<u>Writing</u>
English	Good	Good	Good

7. **Projects Conducted**

Tasks Assigned	Work Undertaken
Biodiversity Report	<p>Name of Assignment or Project: Biodiversity Report for Namibia Uranium (PTY) LTD, EPL 7297.</p> <p>Year: 2021</p> <p>Location: Erongo Region</p> <p>Client: Uranium (PTY) LTD</p> <p>Main project features: Environmental and Biodiversity Impact Assessment</p> <p>Position Held: Biodiversity Specialist</p> <p>Activities performed: Biodiversity Assessment.</p>
D1-Inception Report & Workplan D2-Scoping Report D3-DESIA & ESMP Report D4-ECC Application	<p>Name of Assignment or Project: Biodiversity report for the proposed Erongo substation and associate infrastructure in Karibib Erongo Region, Namibia.</p> <p>Year: 2021</p> <p>Location: Karibib Erongo Region</p> <p>Client: Nampower</p> <p>Main project features: Environmental and Biodiversity Impact Assessment</p> <p>Position Held: Biodiversity Specialist</p> <p>Activities performed: Biodiversity Assessment.</p>

Tasks Assigned	Work Undertaken
D1-Inception Report & Workplan D2-Scoping Report D3-DESIA & ESMP Report D4-ECC Application	<p>Name of Assignment or Project: The Proposed Construction And Operation Of 22 Telecommunication Base Transceiver Station (Bts) Towers Countrywide-Namibia.</p> <p>Year: 2022</p> <p>Location: Country-wide</p> <p>Client: POWERCOM</p> <p>Main project features: Environmental and Social Impact Assessment and Environmental and Social Management Plan.</p> <p>Position Held: Environmentalist</p> <p>Activities performed: Environmental Impact Assessment, Environmental Management plan, Public and Stakeholders Consultation, Reports Drafting and Client liaison</p>